

BONALDO

Pi chair

Designer: **Alain Gilles**



Стул Pi Chair, разработанный Alain Gilles, - это стул с культовым стилем и графичной, строгой структурой, сочетающий в себе минимализм и комфорт. Мягкая, округлая подушка сиденья почти сливается с каркасом из массива дерева, а мягко изогнутая спинка напоминает форму математического знака "Пи", гармонично

объединяя все элементы. Ножки спинки с закругленными краями создают почти графическое соединение с верхней линией спинки. Стул Pi, расположенный вокруг стола, становится центральным элементом пространства с характерным и энергичным присутствием.

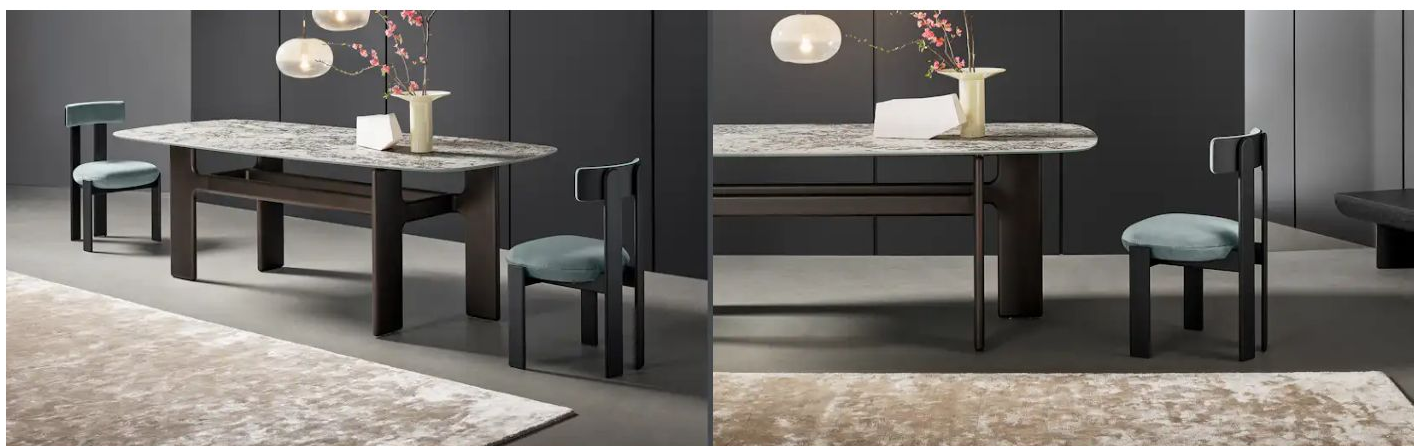

Технические данные

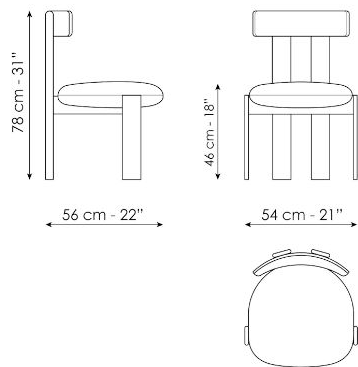

Pi chair

Ширина: 56cm

Глубина: 54cm

Высота: 78cm

Finishes

ОБИВКА

Ткань - 900



Ткань - Azimut
9B02

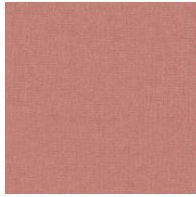

Ткань - Azimut
9B08



Ткань - Azimut
9B17



Ткань - Azimut
9B22



Ткань - Azimut
9B26

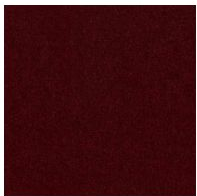

Ткань - Azimut
9B36



Ткань - Azimut
9B39



Ткань - Azimut
9B42



Ткань - Azimut
9B44

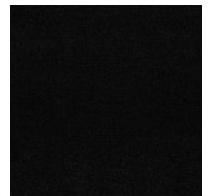

Ткань - Azimut
9B48



Fabric - Newco
9B65

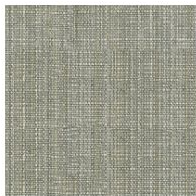

Fabric - Newco
9B66



Fabric - Newco
9B67



Fabric - Newco
9B68



Fabric - Newco
9B69



Fabric - Newco
9B70



Fabric - Newco
9B71



Fabric - Newco
9B72

Ткань - Must



Ткань - Boemian
MC40



Ткань - Boemian
MC43



Ткань - Boemian
MC46



Ткань - Boemian
MC47

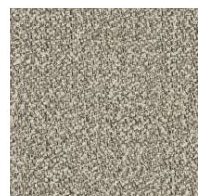

Ткань - Boemian
MC49



Ткань - Rico
MA02

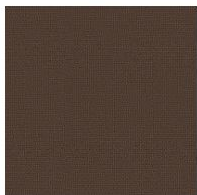

Ткань - Rico
MA04

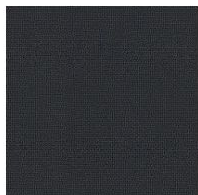

Ткань - Rico
MA07

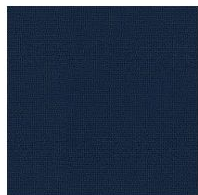

Ткань - Rico
MA09



Ткань - Rico
MA11



Ткань - Rico
MA20

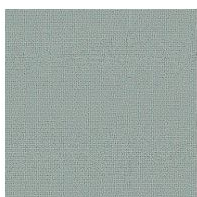

Ткань - Rico
MA22



Ткань - Rico
MA39



Ткань - St. Moritz
MC60



Ткань - St. Moritz
MC61



Ткань - St. Moritz
MC62



Ткань - St. Moritz
MC67



Ткань - St. Moritz
MC69

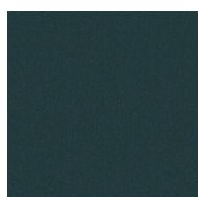

Ткань - St. Moritz
MC76



Ткань - St. Moritz
MC81

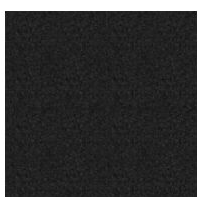

Ткань - St. Moritz
MC83

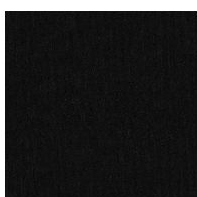

Ткань - St. Moritz
MC85



Ткань - Flora
MD30



Ткань - Flora
MD31



Ткань - Flora
MD32



Ткань - Flora
MD34



Ткань - Flora
MD35



Ткань - Flora
MD37



Ткань - Flora
MD39



Fabric - Lucky
MD58



Fabric - Lucky
MD59



Fabric - Lucky
MD60



Fabric - Lucky
MD61

Ткань - Special



Ткань - Ваia
SP45



Ткань - Ваia
SP48



Ткань - Ваia
SP50

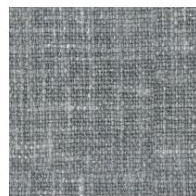

Ткань - Ваia
SP51



Ткань - Ваia
SP52



Fabric - Jurga
SP53



Fabric - Jurga
SP54



Fabric - Jurga
SP55



Fabric - Jurga
SP56



Fabric - Jurga
SP57

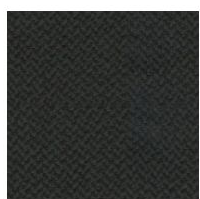

Fabric - Jurga
SP58

Ткань - 800



Ткань - Pastello
8D69



Fabric - Pastello
8D68



Fabric - Pastello
8D67



Fabric - Pastello
8D66



Fabric - Pastello
8D65



Fabric - Pastello
8D64



Fabric - Pastello
8D63



Fabric - Pastello
8D62



Fabric - Pastello
8D61



Fabric - Pastello
8D60



Fabric - Pastello
8D59



Fabric - Pastello
8D58



Fabric - Pastello
8D57



Fabric - Pastello
8D56

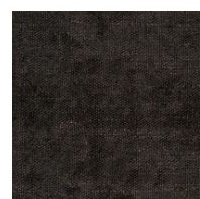

Fabric - Pastello
8D55



Fabric - Pastello
8D54

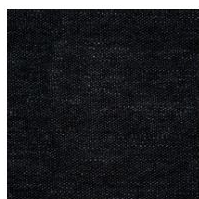

Fabric - Pastello
8D53



Fabric - Pastello
8D52

Ткань - Class



Fabric - Hyle
EB55



Fabric - Hyle
EB56



Fabric - Hyle
EB57



Fabric - Hyle
EB58



Fabric - Hyle
EB59



Fabric - Hyle
EB60



Fabric - Hyle
EB61



Fabric - Hyle
EB62



Fabric - Hyle
EB63

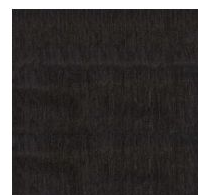

Fabric - Hyle
EB64

НОЖКИ

дерево

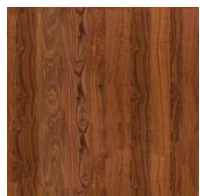

Массив дерева
Американский орех



Массив дерева
Ясень цвет carbone



Solid wood
Grey ash

Materials, fabrics, leathers, colors and finishes are approximate and may slightly differ from actual ones. You can find the complete collection of Bonaldo fabrics and leathers on the website

