



		
	Basi - Bases	Schienali - Backrests		
<b>Rivestimento Upholstering (11)</b>	Sfoderabile Removable			
	Non sfoderabile Not removable	—	—	
<b>Imbottiture Padding (3-4-5-6-7-8-9)</b>	 D.30-65kg/m <sup>3</sup>	 D.75-25kg/m <sup>2</sup> +zavorra	 memory foam & Tecnoform	 ETHICALLY SOFT MADE Optional

## INFORMAZIONI TECNICHE

### Struttura: (1)

Masselli portanti in legno di abete. Elementi strutturali in pannelli di legno multistrati in classe E1, tamponamenti in faesite.

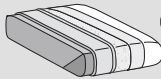
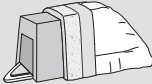
### Molleggio: (2)

Seduta in nastri elastici di fibra propilenica e lattice incrociati e meccanicamente pretensionati.

### Note:

Disponibile con profilo in tessuto Malaga oppure cucitura con ribattitura ad un ago. I modelli Isla e Isla slim non sono affiancabili.

L'ordine di ogni composizione deve sempre essere corredato da un disegno in pianta.

## TECHNICAL INFORMATION

### Structure: (1)

Solid fir wood. Structural elements in multilayer wood panels in class E1, infills in faesite.

### Springing: (2)

Seat with pre-tensioned crossed propylene fibre and latex elastic webbing.

### Note:

Available with Malaga fabric profile or single-needle stitching. The Isla and Isla slim models are not side-by-side.

For orders of compositions a sketch is requested.

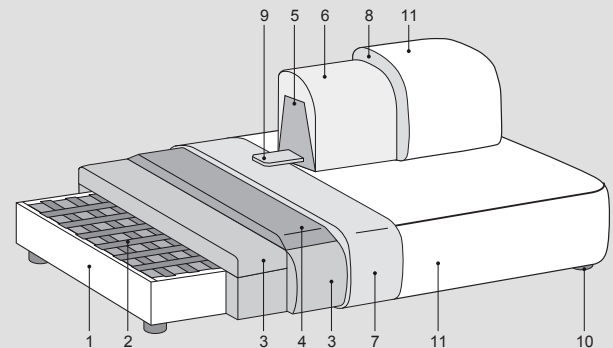
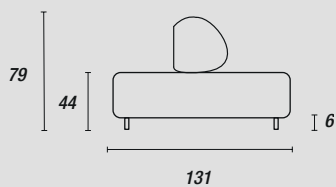

### Piedini - Feet:

di serie

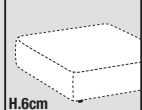

Nero

### Accessori - Accessories:

Con profilo





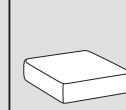





Senza profilo

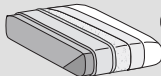

# Isla slim



	 Basi - Bases	 Schienali - Backrests	
<b>Rivestimento Upholstering (11)</b>	Sfoderabile Removable 	Sfoderabile Removable 	
	Non sfoderabile Not removable —	Non sfoderabile Not removable —	
<b>Imbottiture Padding (3-4-5-6-7-8-9)</b>	 D.30-65kg/m³  memory foam & Tecnoform	 D.75-25kg/m³+zavorra 	 ETHICALLY SOFT MADE Optional

## INFORMAZIONI TECNICHE

### Struttura: (1)

Masselli portanti in legno di abete. Elementi strutturali in pannelli di legno multistrati in classe E1, tamponamenti in faesite.

### Molleggio: (2)

Seduta in nastri elastici di fibra propilenica e lattice incrociati e meccanicamente pretensionati.

### Note:

Disponibile con profilo in tessuto Malaga oppure cucitura con ribattitura ad un ago.

I modelli Isla e Isla slim non sono affiancabili.

L'ordine di ogni composizione deve sempre essere corredato da un disegno in pianta.

## TECHNICAL INFORMATION

### Structure: (1)

Solid fir wood. Structural elements in multilayer wood panels in class E1, infills in faesite.

### Springing: (2)

Seat with pre-tensioned crossed propylene fibre and latex elastic webbing.

### Note:

Available with Malaga fabric profile or single-needle stitching.

The Isla and Isla slim models are not side-by-side.

For orders of compositions a sketch is requested.

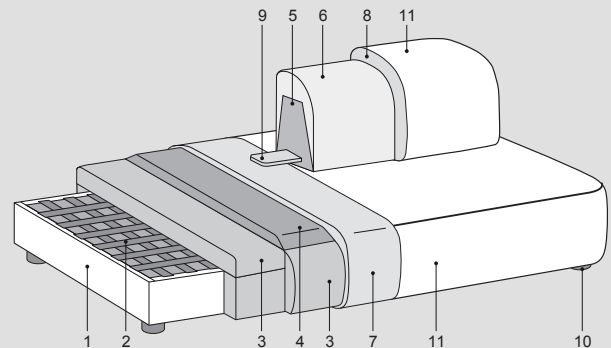
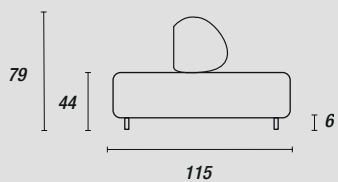

Piedini - Feet:

di serie

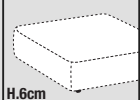

Nero

Accessori - Accessories:

Con profilo



Senza profilo

