

COPINE GIREVOLE

Design G. & O. Buratti

POLTRONA | ARMCHAIR

2022



COPINE GIREVOLE

Design G. & O. Buratti

POLTRONA | ARMCHAIR

2022

Poltrona con basamento girevole con meccanismo di ritorno in metallo finitura grigio peltro e rivestimento nei tessuti della collezione. Rivestimento sfoderabile in tessuto e non sfoderabile in pelle. Possibilità di combinare diversi tessuti per la struttura imbottita interna ed esterna. Scocca interna in multistrato di pioppo e massello di abete con sedile cinghiato. Imbottitura in poliuretano a quote differenziate.

Armchair with swivel metal base with returning mechanism in grey pewter finish and cover in the fabrics of the collection. The cover is removable in fabric and fixed in leather. It is possible to combine different fabrics for the outer and inner parts of the upholstered structure. Inner shell in poplar plywood and solid fir wood with belted seat. The padding is in crush-proof polyurethane foam with different densities.

Sessel mit drehbarem Metallgestell mit Rückholssystem aus zinngrauer Ausführung und Polsterung in den Stoffen der Kollektion. Abnehmbarer Bezug aus Stoff und nicht abnehmbar aus Leder. Es können verschiedene Stoffe für innen und außen kombiniert werden. Innenschale aus Pappel und massivem Tannensperrholz mit Sitzgurten. Polsterung aus Polyurethan unterschiedlicher Dichte.

Fauteuil avec base pivotante en métal en finition gris peltre avec mécanisme de retour et revêtement dans les tissus de la collection. Revêtement déhoussable en tissu mais fixe en cuir. Possibilité de combiner tissus différents pour la partie intérieure et extérieure de la structure rembourrée. Coque intérieure en peuplier contreplaqué et sapin massif et assise avec sangles. Rembourrage en polyuréthane à densité différenciée.

Butaca con base giratoria de metal acabado gris peltre con retorno automático y revestimiento desenfundable en las telas de la colección y no desenfundable en piel. Es posible combinar diferentes telas para la parte frontal del respaldo y el asiento y para la parte trasera del respaldo y la parte baja de la estructura. Estructura interna en contrachapado de álamo y abeto macizo, con asiento con correas. Relleno de poliuretano expandido de densidades diferenciadas.

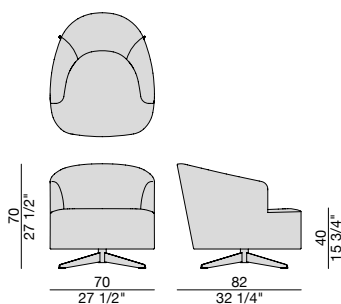

COPINE GIREVOLE

Design G. & O. Buratti

POLTRONA | ARMCHAIR

2022



COPINE GIREVOLE

Design G. & O. Buratti

POLTRONA | ARMCHAIR

2022

Metallo | *Metal*

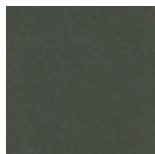

Grigio Peltro
Grey Pewter

COPINE GIREVOLE

Design G. & O. Buratti

POLTRONA | ARMCHAIR

2022

Pelle | Leather

Cat. LUX

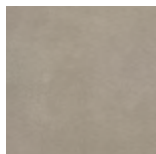

Nabuk

Cat. PLUS

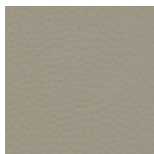

Pelle PLUS

Cat. EXTRA

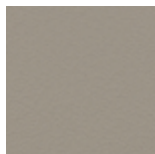

Pelle EXTRA

Cat. PELLE



Pelle

Rivestimento | Cover

Cat. A



Twist

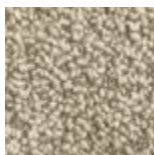

Zante

Cat. B



Bouclage

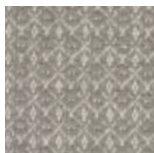

Motley



Tammy



Rabat

Cat. C



Armam



Ikat

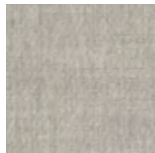

Lint



Loom



Madras

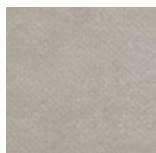

Moleskin



Moran

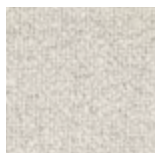

Patch

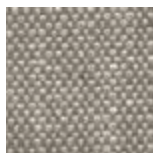

Silesia

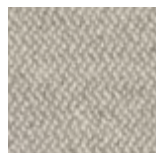

Serge

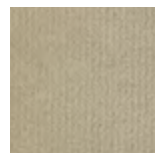

Velvet

Cat. D

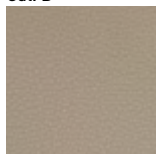

Paros
eco leather

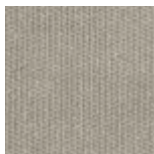

Range



Tress

Cat. E



Dorian



In Bianco/Calico

Cat. COM

Disponibile con tessuto fornito dal cliente.

Available with fabric supplied by the customer.

Verfügbar mit Kundenstoff.

Disponibile avec tissu du client.

Disponibile con tela suministrada por el cliente.