

BEAM

Design G. & O. Buratti

TAVOLO | TABLE

2021



BEAM C

Design G. & O. Buratti

TAVOLO | TABLE

2021

Tavolo da pranzo con due basi a mezzaluna in noce canaletta unite da una trave centrale in legno. Piano in cristallo trasparente (spessore 15 mm) e puntali in metallo.

Dining table with two half-moon bases in canaletta walnut joined by a wooden beam. Top in clear glass (thickness 15 mm) and metal end-feet.

Esstisch mit zwei halbmondförmigen Untergestellen aus Nussbaum Canaletta, die durch einen Holzbalken verbunden sind. Tischplatte aus Klarglas (Stärke 15 mm) und Endfüße aus Metall.

Table de repas avec deux piétements à demi-lune en noyer canaletta unis par une poutre en bois. Plateau en verre transparent (épaisseur 15 mm) et embouts en métal.

Mesa de comedor con dos bases en forma de media luna en nogal canaletta unidas por una viga de madera. Tapa en cristal transparente (espesor 15 mm). Pies acabados en metal.

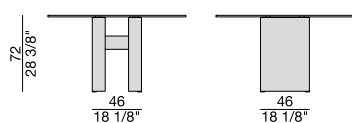
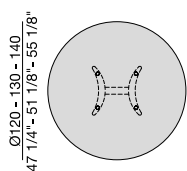

BEAM TONDO C

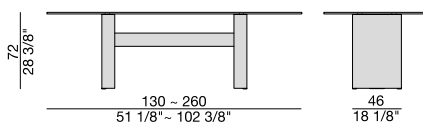
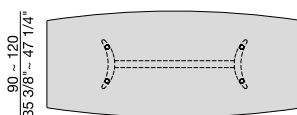

BEAM BOTTE C

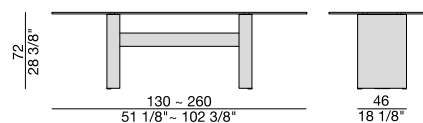
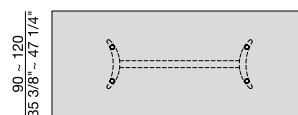

BEAM RETTANGOLARE C

Essenze | Wood

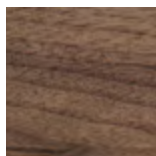

Noce canaletta
Canaletta walnut

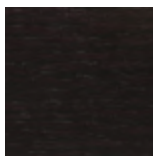

Noce canaletta
tinto moka
Canaletta walnut
moka stained

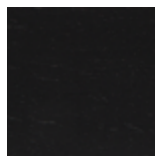

Noce canaletta
tinto wengè
Canaletta walnut
wengè stained

Laccato opaco poro chiuso | Matt Lacquered closed pore

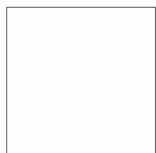

Bianco
White
(RAL 9016)



Avorio
Ivory
(RAL 1013)



Argilla
Argilla
(RAL 7006)



Cioccolato
Chocolate
(RAL 8019)

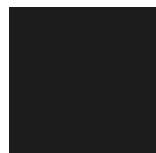

Nero
Black
(RAL 9005)



Iron
Iron
(RAL 7011)



Granata
Granata
(NCS S4050Y90R)

Metallo | Metal

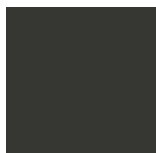

Cromo nero
Black chromed



Ottone spazzolato
Brushed brass

Cristallo | Glass



Trasparente
Transparent

Tavolo da pranzo con due basi a mezzaluna in noce canaletta unite da una trave centrale in legno. Piano in legno (spessore 40 mm) con sagomatura a smusso perimetrale e puntali in metallo.

Dining table with two half-moon bases in canaletta walnut joined by a wooden beam. Top in wood (thickness 40 mm) with bevelled perimeter edge and metal end-feet.

Esstisch mit zwei halbmondförmigen Untergestellen aus Nussbaum Canaletta, die durch einen Holzbalken verbunden sind. Tischplatte aus Holz (Dicke 40 mm) mit abgeschrägter Umfangskante und Endfüßen aus Metall.

Table de repas avec deux piétements à demi-lune en noyer canaletta unis par une poutre en bois. Plateau en bois (épaisseur 40 mm) avec bord biseauté et embouts en métal.

Mesa de comedor con dos bases en forma de media luna en nogal canaletta unidas por una viga de madera. Tapa en madera (espesor 40 mm) con borde biselado. Pies acabados en metal.

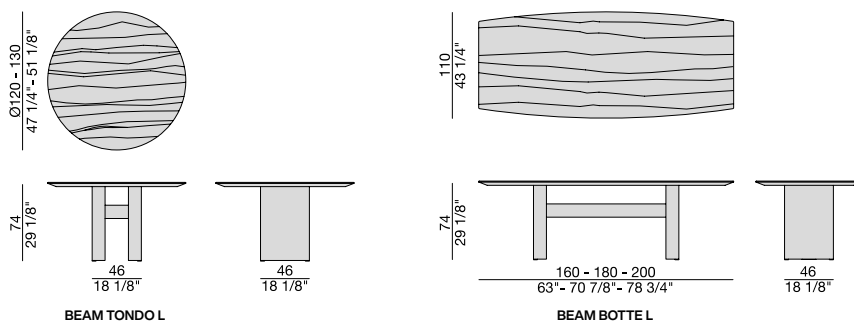

Esenze | Wood

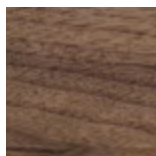

Noce canaletta
Canaletta walnut

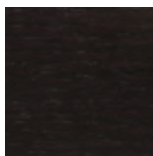

Noce canaletta
tinto moka
*Canaletta walnut
moka stained*

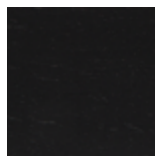

Noce canaletta
tinto wengè
*Canaletta walnut
wengè stained*

Laccato opaco poro chiuso | Matt Lacquered closed pore

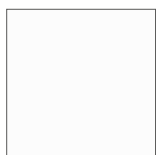

Bianco
White
(RAL 9016)



Avorio
Ivory
(RAL 1013)



Argilla
Argilla
(RAL 7006)



Cioccolato
Chocolate
(RAL 8019)



Nero
Black
(RAL 9005)



Iron
Iron
(RAL 7011)



Granata
Granata
(NCS S4050Y90R)

Metallo | Metal



Cromo nero
Black chromed



Ottone spazzolato
Brushed brass

Tavolo da pranzo con due basi a mezzaluna in noce canaletta unite da una trave centrale in legno. Piano in marmo (spessore 20 mm) con sagomatura a musso perimetrale e sottopiano laccato nero opaco. Puntali in metallo.

Dining table with two half-moon bases in canaletta walnut joined by a wooden beam. Top in marble (thickness 20 mm) with bevelled perimeter edge and black matt lacquered top support. Metal end-feet.

Esstisch mit zwei halbmondförmigen Untergestellen aus Nussbaum Canaletta, die durch einen Holzbalken verbunden sind. Platte aus Marmor (Stärke 20 mm) und schwarz matt lackierter oberer Träger. Endfüße aus Metall.

Table de repas avec deux piétements à demi-lune en noyer canaletta unis par une poutre en bois. Plateau en marbre (épaisseur 20 mm) avec bord biseauté, doublé d'un plateau porteur laqué noir mat. Embouts en métal.

Mesa de comedor con dos bases en forma de media luna en nogal canaletta unidas por una viga de madera. Tapa en mármol (espesor 20 mm) con borde biselado sujetada por un panel lacado negro. Pies acabados en metal.

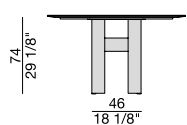
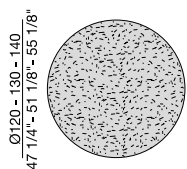

BEAM TONDO M

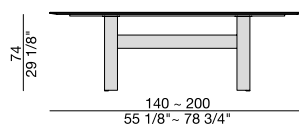
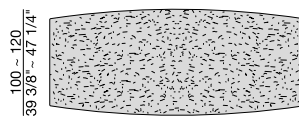

BEAM BOTTE M

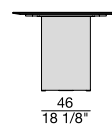

Essenze | Wood

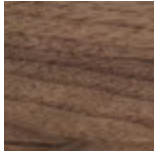

Noce canaletta
Canaletta walnut

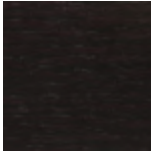

Noce canaletta
tinto moka
Canaletta walnut
moka stained



Noce canaletta
tinto wengè
Canaletta walnut
wengè stained

Laccato opaco poro chiuso | Matt Lacquered closed pore

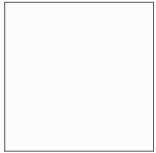

Bianco
White
(RAL 9016)



Avorio
Ivory
(RAL 1013)



Argilla
Argilla
(RAL 7006)



Cioccolato
Chocolate
(RAL 8019)



Nero
Black
(RAL 9005)



Iron
Iron
(RAL 7011)



Granata
Granata
(NCS S4050Y90R)

Metallo | Metal



Cromo nero
Black chromed



Ottone spazzolato
Brushed brass

Marmo | Marble

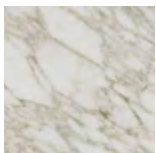

Bianco Calacatta oro
white Calacatta gold

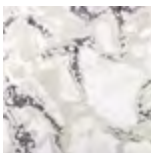

Dover white
Dover white



Roma Imperiale
Imperial Rome

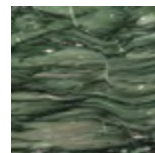

Verde Lapponia
Lapponia green

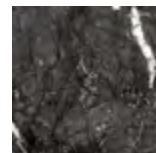

Grigio Carnico
grey Carnico

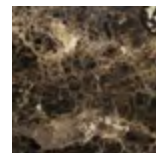

Marrone Emperador
dark
Emperador Dark
brown

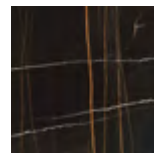

Nero Sahara noir
Black Sahara noir

BEAM ROCK

Design G. & O. Buratti

TAVOLO | TABLE

2021

Tavolo da pranzo con due basi a mezzaluna in noce canaletta unite da una trave centrale in legno. Piano in Rock (spessore 6 mm) e sottopiano laccato nero opaco. Puntali in metallo.

Dining table with two half-moon bases in canaletta walnut joined by a wooden beam. Top in Rock (thickness 6 mm) and black matt lacquered top support. Metal end-feet.

Esstisch mit zwei halbmondförmigen Untergestellen aus Nussbaum Canaletta, die durch einen Holzbalken verbunden sind. Platte in Rock (Stärke 6 mm) und schwarz matt lackierter oberer Träger. Endfüße aus Metall.

Table de repas avec deux piétements à demi-lune en noyer canaletta unis par une poutre en bois. Plateau en Rock (épaisseur 6 mm), doublé d'un plateau porteur laqué noir mat. Embouts en métal.

Mesa de comedor con dos bases en forma de media luna en nogal canaletta unidas por una viga de madera. Tapa en Rock (espesor 6 mm) sujetada por un panel lacado negro. Pies acabados en metal.

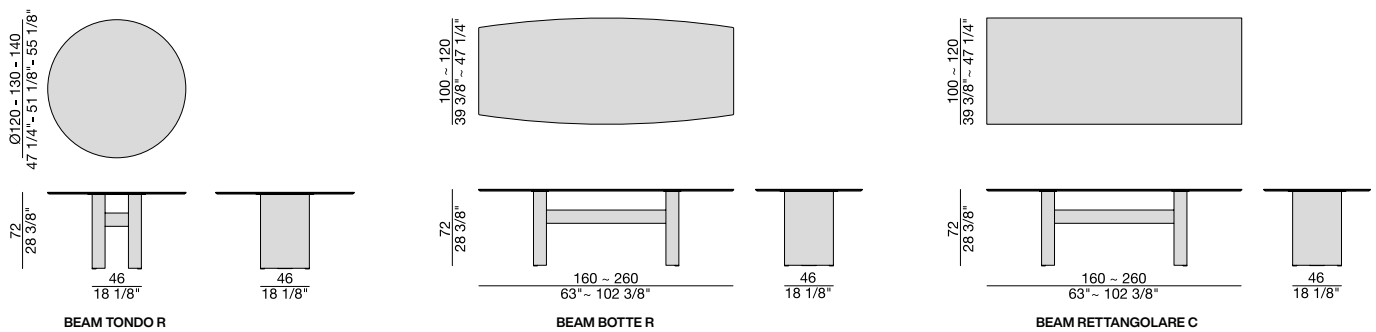

Esenze | Wood

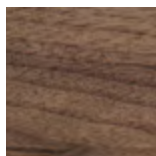

Noce canaletta
Canaletta walnut

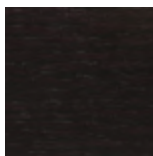

Noce canaletta
tinto moka
*Canaletta walnut
moka stained*

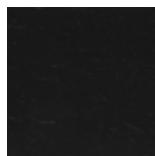

Noce canaletta
tinto wengè
*Canaletta walnut
wengè stained*

Laccato opaco poro chiuso | Matt Lacquered closed pore

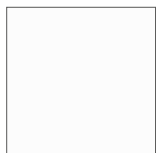

Bianco
White
(RAL 9016)



Avorio
Ivory
(RAL 1013)



Argilla
Argilla
(RAL 7006)



Cioccolato
Chocolate
(RAL 8019)



Nero
Black
(RAL 9005)



Iron
Iron
(RAL 7011)



Granata
Granata
(NCS S4050Y90R)

Metallo | Metal



Cromo nero
Black chromed



Ottone spazzolato
Brushed brass

Rock | Rock



Calacatta opaco
matt Calacatta

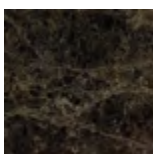

Emperador opaco
matt Emperador



Pearl opaco
matt Pearl

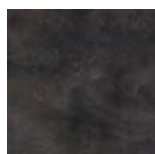

Black Oxide opaco
matt Black Oxide

BEAM

Design G. & O. Buratti

TAVOLO | TABLE

2021

