



Cut, 910/PL
bergère \ bergère

Cut nasce dalla volontà di sviluppare una seduta dalle forme ergonomiche e avvolgenti. Il risultato è una bergère dall'aspetto leggero ed estremamente confortevole, grazie anche ai cuscini di seduta e poggiatesta a due regolazioni, sostenuta da un'essenziale base in alluminio verniciato nero goffrato, proposta in due versioni: fissa e girevole a quattro razze. La versione girevole è reclinabile con blocco in 5 posizioni. I profili netti e le cuciture a vista in corrispondenza delle incisioni conferiscono alla seduta un look tailor-made. Accompagna la bergère l'omonimo poggiatesta, con base fissa e a quattro razze, che ne riprende le caratteristiche estetiche.

Cut was born from the desire to develop a seat with ergonomic and enveloping shapes. The result is a bergère with a light and extremely comfortable appearance, thanks also to the seat and headrest cushions, with two settings, supported by an essential embossed black painted aluminium base, available in two versions: fixed and swivel with fourstar base. The swivel version is reclining, with 5 block positions. The neat profiles and visible stitching in correspondence of the incisions, give the seat a tailor-made look. The bergère is accompanied by the homonymous footrest, with a fixed or four-star swivel base, resuming its aesthetic characteristics.

Informazioni tecniche \ Technical information

Descrizione tecnica \ Technical description

Bergère con base in alluminio verniciato nero goffrato. Seduta imbottita in poliuretano espanso ignifugo. Poggiatesta a due regolazioni. Rivestimenti di collezione.

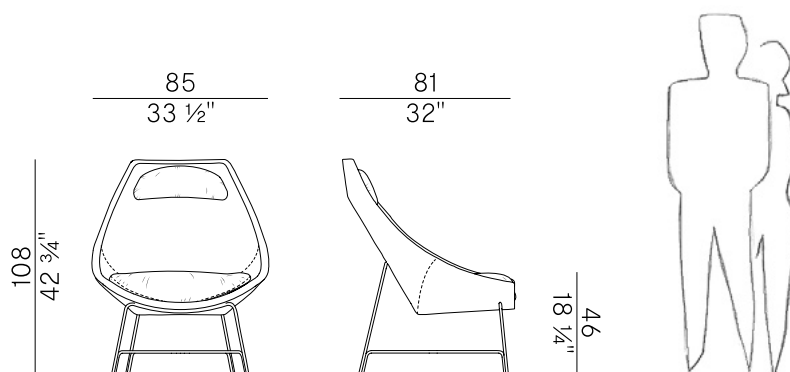

Bergère with embossed black painted aluminum base. Seat padded in fire retardant polyurethane foam. Headrest with two settings. Coverings as per collection.

Dimensioni \ Dimensions





Consumi stoffe \ Fabric and leather requirements

FABRIC / LEATHER REQUIREMENTS

	x1	x2
 H 140	ml 3,80	ml 7,60
 LEATHER	m ² 8,50	

FABRIC / LEATHER REQUIREMENTS

	x1	x2
 H 55 1/4"	yd 4,20	yd 8,35
 LEATHER	ft ² 92	



PACKAGING

1 x box = m³ 0.83
gross weight - Kg 28

Finiture \ Finishes

Finiture struttura \
Frame finishes

Alluminio goffrato \ Embossed aluminium 



Nero \
Black

Rivestimenti \
Coverings

Tessuto, finta pelle, pelle \ Fabric, faux leather, leather

Collezione Cut \
Cut collection

Collezione costituita da bergère e pouf/
poggiapiedi.

Bergère in due versioni:

- Fissa con struttura in alluminio verniciato nero goffrato e pouf/poggiapiedi con struttura in alluminio verniciato nero goffrato.
- Girevole, senza meccanismo di ritorno, con base a quattro razze in alluminio verniciato nero goffrato, seduta con sistema reclinabile con blocco in 5 posizioni e poggiatesta a due regolazioni. Pouf/poggiapiedi con base a quattro razze in alluminio verniciato nero goffrato. Imbottiture in poliuretano espanso ignifugo. Rivestimenti di collezione.

Collection composed of bergère and footrest/pouf.

Bergère in two versions:

- Fixed with embossed black painted aluminum structure and pouf/footrest with embossed black painted aluminum structure.
- Swivel, without return mechanism, with four-star swivel base in embossed black painted aluminum, seat with reclining system with 5-position lock and two-adjustment headrest. Pouf/footrest with four-star base in embossed black painted aluminum. Padding in fire retardant polyurethane foam. Coverings as per collection.

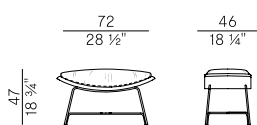

910/PP
pouf \ pouf

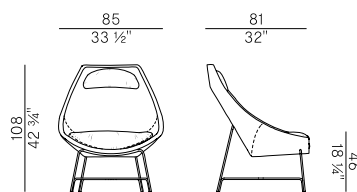

910/PL
bergère \ bergère

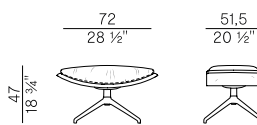

910/PPG
pouf \ pouf

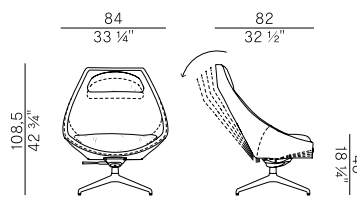

910/PLG
bergère girevole e reclinabile \ swivel and reclining bergère



Cut, 910/PP
pouf \ pouf

Cut nasce dalla volontà di sviluppare una seduta dalle forme ergonomiche e avvolgenti. Il risultato è una bergère dall'aspetto leggero ed estremamente confortevole, grazie anche ai cuscini di seduta e poggiatesta a due regolazioni, sostenuta da un'essenziale base in alluminio verniciato nero goffrato, proposta in due versioni: fissa e girevole a quattro razze. La versione girevole è reclinabile con blocco in 5 posizioni. I profili netti e le cuciture a vista in corrispondenza delle incisioni conferiscono alla seduta un look tailor-made. Accompagna la bergère l'omonimo poggiatesta, con base fissa e a quattro razze, che ne riprende le caratteristiche estetiche.

Cut was born from the desire to develop a seat with ergonomic and enveloping shapes. The result is a bergère with a light and extremely comfortable appearance, thanks also to the seat and headrest cushions, with two settings, supported by an essential embossed black painted aluminium base, available in two versions: fixed and swivel with fourstar base. The swivel version is reclining, with 5 block positions. The neat profiles and visible stitching in correspondence of the incisions, give the seat a tailor-made look. The bergère is accompanied by the homonymous footrest, with a fixed or four-star swivel base, resuming its aesthetic characteristics.

Informazioni tecniche \ Technical information

Descrizione tecnica \ Technical description

Pouf con base in alluminio verniciato nero goffrato. Imbottito in poliuretano espanso ignifugo. Rivestimenti di collezione.

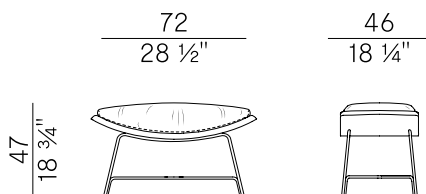

Pouf with base in embossed black painted aluminum. Padded in fire retardant polyurethane foam. Coverings as per collection.

Dimensioni \ Dimensions



Consumi stoffe \ Fabric and leather requirements

FABRIC / LEATHER REQUIREMENTS



	x1	x2
 H 140	ml 1,50	ml 3,00
 LEATHER	m ² 2,90	



PACKAGING

1 x box = m³ 0,21
gross weight - Kg 12

FABRIC / LEATHER REQUIREMENTS

	x1	x2
 H 55 1/4"	yd 1,65	yd 3,30
 LEATHER	ft ² 32	

Finiture \ Finishes

Finiture struttura \
Frame finishes

Alluminio goffrato \ Embossed aluminium 



Nero \
Black

Rivestimenti \
Coverings

Tessuto, finta pelle, pelle \ Fabric, faux leather, leather

Collezione Cut \
Cut collection

Collezione costituita da bergère e pouf/
poggiapiedi.

Bergère in due versioni:

- Fissa con struttura in alluminio verniciato nero goffrato e pouf/poggiapiedi con struttura in alluminio verniciato nero goffrato.
- Girevole, senza meccanismo di ritorno, con base a quattro razze in alluminio verniciato nero goffrato, seduta con sistema reclinabile con blocco in 5 posizioni e poggiatesta a due regolazioni. Pouf/poggiapiedi con base a quattro razze in alluminio verniciato nero goffrato. Imbottiture in poliuretano espanso ignifugo. Rivestimenti di collezione.

Collection composed of bergère and footrest/pouf.

Bergère in two versions:

- Fixed with embossed black painted aluminum structure and pouf/footrest with embossed black painted aluminum structure.
- Swivel, without return mechanism, with four-star swivel base in embossed black painted aluminum, seat with reclining system with 5-position lock and two-adjustment headrest. Pouf/footrest with four-star base in embossed black painted aluminum. Padding in fire retardant polyurethane foam. Coverings as per collection.

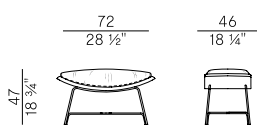

910/PP
pouf \ pouf

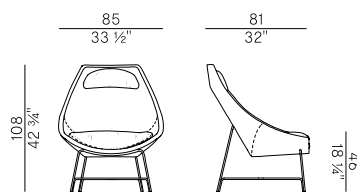

910/PL
bergère \ bergère

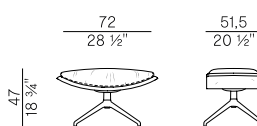

910/PPG
pouf \ pouf

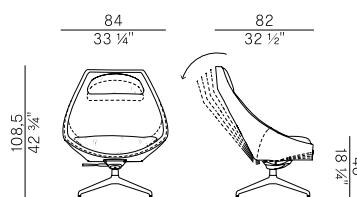

910/PLG
bergère girevole e reclinabile \ swivel and reclining bergère