



Double L, 952 /TC
tavolino \ coffee table

Il tavolino Double L, ideale da posizionare di fianco a un divano o accostato ad altri tavolini, è costituito da due gambe in lamiera d'acciaio nero goffrato che diventano due segni grafici uniti da un elemento centrale in ottone brunito. Il piano è disponibile in marmo, nelle finiture a collezione.

The Double L coffee table, which is ideal for placing next to a sofa or next to other coffee tables, consists of two legs in embossed black steel sheet that become two graphic signs joined by a central element in bronzed brass. The top is available in marble, in the finishes as per collection.

Informazioni tecniche \ Technical information

Descrizione tecnica \ Technical description

Tavolino con piano circolare e base in lamiera d'acciaio verniciata a polveri epossidiche finitura nero gofrato. Raccordo tra le basi in ottone brunito e piano in marmo. Finiture di collezione.

Coffee table with circular top and base in epoxy powder coated steel sheet with black embossed finish. Connection between the bases in bronzed brass and marble top. Finishes as per collection.

Dimensioni \ Dimensions

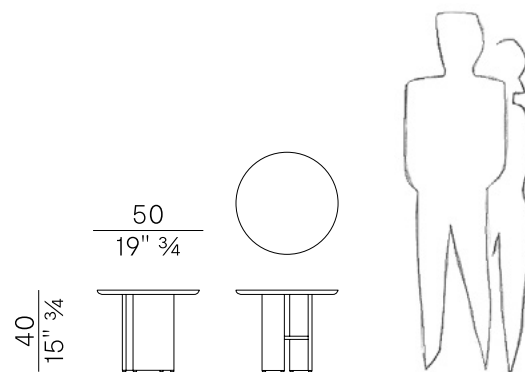

Imballaggi \ Packaging



PACKAGING

1 × box = m³ 0.17

gross weight – Kg 18

Finiture \ Finishes

Finiture base \
Base finishes

Metallo verniciato \ Lacquered metal



Nero goffrato \
Embossed black

Finiture dettaglio \
Detail finishes

Metallo \ Metal

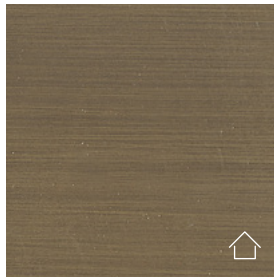

Ottone brunito \
Bronzed brass

Finiture \ Finishes

Finiture piano \
Top finishes

Marmo \ Marble 

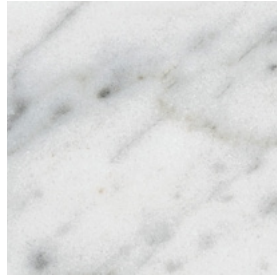

Bianco Carrara opaco \
Matt White Carrara



Bianco Carrara lucido \
Glossy White Carrara



Fior di Pesco Carnico \
Fior di Pesco Carnico

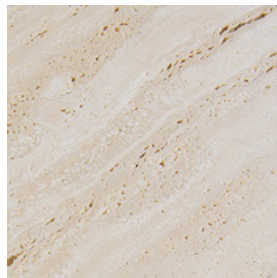

Travertino Romano \
Travertino Romano

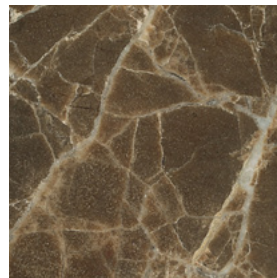

Dark Emperador \
Dark Emperador

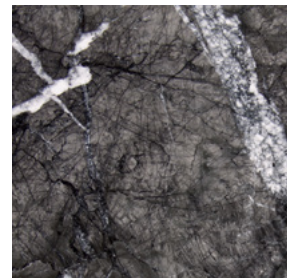

Grigio Carnico \
Grigio Carnico

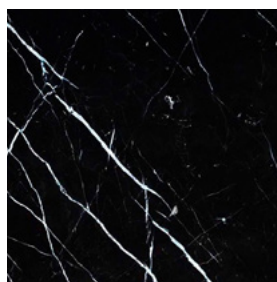

Nero Marquinia \
Nero Marquinia