



Graphic, 955/SCR
scrittoio \ writing desk

Il progetto di Graphic è stato sviluppato da Victor Vasilev e Mario Ferrarini come estensione della collezione di sedute Keel mantenendo lo stesso codice compositivo. Una struttura di elementi sottili e geometrici si unisce armoniosamente con dei piani funzionali, dando vita a tavoli, panca, scrittoio e tavolini accessori con piani anche in massello di frassino. Il risultato finale è una collezione caratterizzata da un'assoluta semplicità strutturale che garantisce la perfetta combinazione con le famiglie di sedute firmate Potocco.

Graphic has been designed by Victor Vasilev and Mario Ferrarini as an extension of the Keel chair collection, maintaining the same composition characteristics. The structure, composed of thin and geometrical elements, is harmoniously combined with functional surfaces, creating tables, the bench, the writing desk and complementary coffee tables, with top available also in solid ash wood. The result is a collection characterized by an absolute structural simplicity that ensures its perfect combination with the Potocco seat families.

Informazioni tecniche \ Technical information

Descrizione tecnica \
Technical description

Scrivania con base in metallo verniciato
antracite o Aval e piano in massello di
frassino.

Writing desk with anthracite or Aval
lacquered metal base and solid ash
wood top.

Dimensioni \
Dimensions

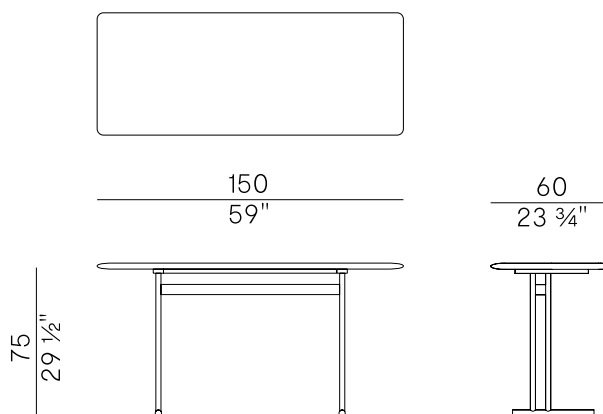

Finiture \ Finishes

Finiture base\
Base finishes

Metallo verniciato \ Lacquered metal  

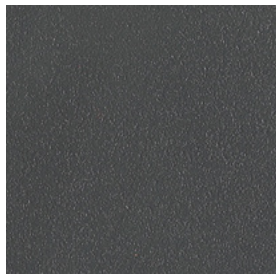

Antracite goffrato \
Embossed anthracite



Aval goffrato \
Embossed Aval

Finiture \ Finishes

Finiture piano \
Top finishes

Frassino \ Ash 



SG
Beige \
Beige



SC
Biscotto \
Biscuit

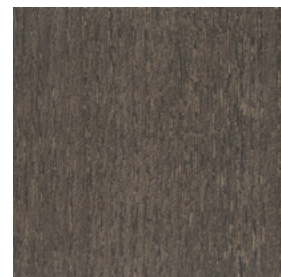

HJ
Moka \
Moka

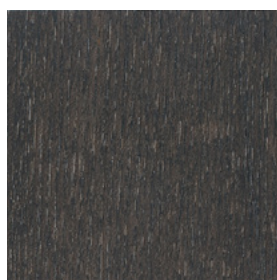

HK
Grigio plumbeo \
Dark grey

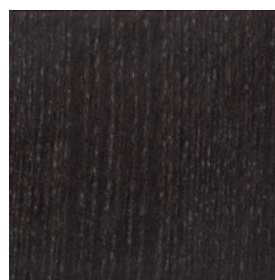

HL
Wengé \
Wengé

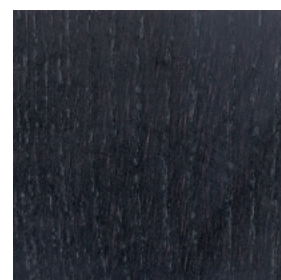

HP
Carbone \
Carbon

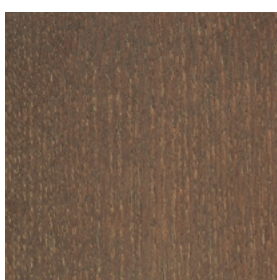

SN
Noce \
Walnut

Collezione Graphic \
Graphic collection

Collezione di tavoli e panca, con struttura
in metallo verniciato antracite o Aval.

La collezione è così composta:

- Panca con seduta in massello di frassino.
- Tavolo e tavolo alto con piano circolare
in massello di frassino.
- Tavolo rettangolare con piano in massello
di frassino.
- Scrivania con piano in massello di frassino.
- Tavolini, a tre altezze, con piano in massello
di frassino o marmo.

Finiture di collezione.

Collection of tables and bench, with
anthracite or Aval lacquered metal base.

The collection is composed as follows:

- Bench with solid ash wood seat.
- Table and high table with solid ash
wood round top.
- Rectangular table with solid ash
wood top.
- Writing desk with solid ash wood top
- Coffee tables, in three heights, with
top in solid ash wood or marble.

Finishes as per collection.

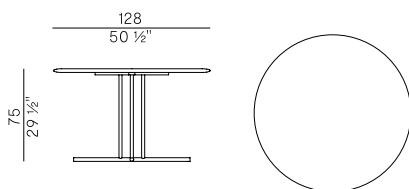

955/TGC

tavolo \ table

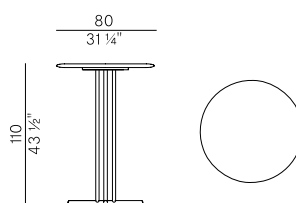

955/TAC

tavolo alto \ high table

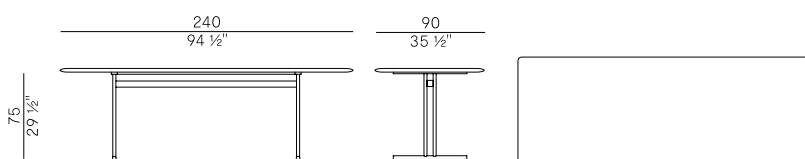

955/TR

tavolo \ table

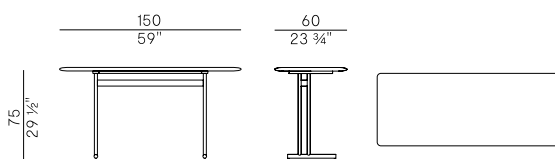

955/SCR

scrivania \ writing desk

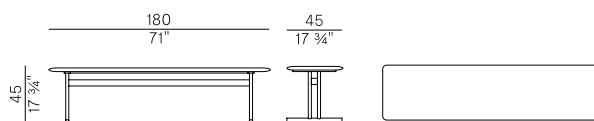

955/O

panca \ bench

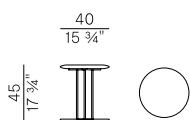

955/TBC-40

tavolino \ coffee table

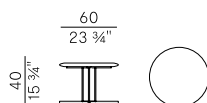

955/TBC-60

tavolino \ coffee table

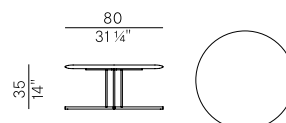

955/TBC-80

tavolino \ coffee table