



Keel, 922/S-OUT  
sgabello basso \ counterstool

La famiglia Keel composta da sedia e poltroncina dining, poltrona e sgabelli a due altezze, nasce da una ricerca sul tema del rapporto tra rigore geometrico e sinuosità organica. Keel, che si differenzia dalla collezione Keel Light per la seduta interamente imbottita, rimanda al mondo della nautica, rappresentando il tentativo di trovare il miglior equilibrio tra una struttura lineare in tondino di acciaio ed elementi d'appoggio in massello di iroko dalle forme morbide e sinuose che presentano una lavorazione molto particolare. Keel è disponibile anche nella versione indoor in massello di frassino.

The Keel family, consisting of dining chair and dining armchair, armchair and two-height stools, was born from the research of the relationship between geometric rigor and organic sinuosity. Keel, which differs from the Keel Light collection for the fully upholstered seat, refers to the nautical world, representing the attempt to find the best balance between a linear structure in steel rod and support elements in solid ash wood with soft and sinuous shapes that have a very particular manufacturing process. Keel is available also in the indoor version in solid ash wood.

## Informazioni tecniche \ Technical information

### Descrizione tecnica \ Technical description



Sgabello basso con struttura in tondino di acciaio verniciato goffrato antracite, Aval o bianco perla. Schienale in massello di iroko e seduta imbottita in poliuretano espanso ignifugo. Finiture e rivestimenti di collezione.

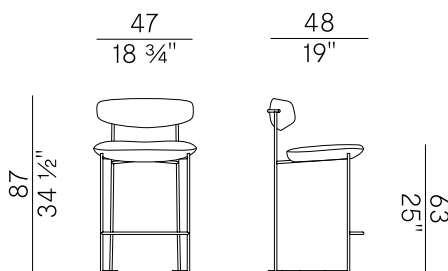

Counterstool with structure in anthracite, Aval or pearl white embossed painted steel rod. Backrest in solid iroko wood and seat padded in fire retardant polyurethane foam. Materials and coverings as per collection.

### Dimensioni \ Dimensions



### Consumi stoffe \ Fabric requirements

| FABRIC REQUIREMENTS   |                |                     |         |
|---|----------------|---------------------|---------|
|   |                | x1                  | x2      |
|  | <b>H 140</b>   | ml 0,65             | ml 1,30 |
|  | <b>LEATHER</b> | m <sup>2</sup> 1,30 |         |

| FABRIC REQUIREMENTS   |                  |                    |         |
|---|------------------|--------------------|---------|
|   |                  | x1                 | x2      |
|  | <b>H 55 1/4"</b> | yd 0,72            | yd 1,44 |
|  | <b>LEATHER</b>   | ft <sup>2</sup> 14 |         |



### PACKAGING

1 × box = m<sup>3</sup> 0.24  
gross weight – Kg 134

## Finiture \ Finishes

Finiture struttura \  
Frame finishes

Metallo verniciato \ Lacquered metal  



Antracite goffrato \  
Anthracite embossed



Aval goffrato \  
Aval embossed

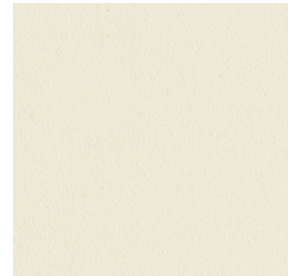

Bianco perla goffrato \  
Pearl white embossed

Finiture schienale \  
Backrest finishes

Iroko \ Iroko  



EU  
Iroko \  
Iroko

Rivestimenti \  
Coverings

Tessuto outdoor \ Outdoor fabric

Collezione outdoor Keel \ Keel outdoor collection

Collezione costituita da sedia e poltroncina dining, poltrona e sgabelli a due altezze. Struttura in tondino d'acciaio verniciato a polveri epossidiche per outdoor nelle finiture antracite, Aval e bianco perla, schienale in massello di iroko. Seduta imbottita in poliuretano espanso ignifugo. Rivestimenti di collezione.

Collection consisting of dining chair and armchair, armchair and stools in two heights. Structure in anthracite, Aval or pearl white embossed steel rod for outdoor, backrest in solid iroko wood. Upholstered seat in fire retardant polyurethane foam. Coverings as per collection.

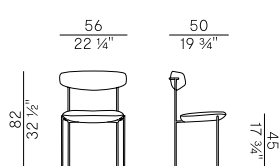

922-OUT  
sedia dining \ dining chair

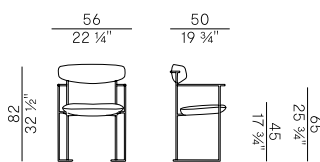

922/P-OUT  
poltroncina dining \ dining armchair

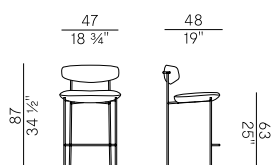

922/S-OUT  
sgabello basso \ counterstool

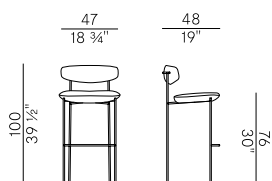

922/A-OUT  
sgabello alto \ barstool

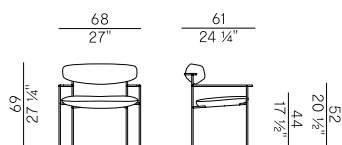

922/L-OUT  
poltrona \ armchair



Keel, 922/A-OUT  
sgabello alto \ barstool

La famiglia Keel composta da sedia e poltroncina dining, poltrona e sgabelli a due altezze, nasce da una ricerca sul tema del rapporto tra rigore geometrico e sinuosità organica. Keel, che si differenzia dalla collezione Keel Light per la seduta interamente imbottita, rimanda al mondo della nautica, rappresentando il tentativo di trovare il miglior equilibrio tra una struttura lineare in tondino di acciaio ed elementi d'appoggio in massello di iroko dalle forme morbide e sinuose che presentano una lavorazione molto particolare. Keel è disponibile anche nella versione indoor in massello di frassino.

The Keel family, consisting of dining chair and dining armchair, armchair and two-height stools, was born from the research of the relationship between geometric rigor and organic sinuosity. Keel, which differs from the Keel Light collection for the fully upholstered seat, refers to the nautical world, representing the attempt to find the best balance between a linear structure in steel rod and support elements in solid ash wood with soft and sinuous shapes that have a very particular manufacturing process. Keel is available also in the indoor version in solid ash wood.

## Informazioni tecniche \ Technical information

### Descrizione tecnica \ Technical description

Sgabello alto con struttura in tondino di acciaio verniciato goffrato antracite, Aval o bianco perla. Schienale in massello di iroko e seduta imbottita in poliuretano espanso ignifugo. Finiture e rivestimenti di collezione.

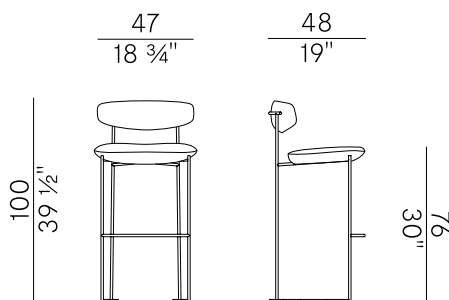

Barstool with structure in anthracite, Aval or pearl white embossed painted steel rod. Backrest in solid iroko wood and seat padded in fire retardant polyurethane foam. Materials and coverings as per collection.

### Dimensioni \ Dimensions



### Consumi stoffe \ Fabric requirements

| FABRIC REQUIREMENTS   |                |                     |         |
|---|----------------|---------------------|---------|
|   |                | x1                  | x2      |
|  | <b>H 140</b>   | ml 0,65             | ml 1,30 |
|  | <b>LEATHER</b> | m <sup>2</sup> 1,30 |         |

| FABRIC REQUIREMENTS   |                  |                    |         |
|---|------------------|--------------------|---------|
|   |                  | x1                 | x2      |
|  | <b>H 55 1/4"</b> | yd 0,72            | yd 1,44 |
|  | <b>LEATHER</b>   | ft <sup>2</sup> 14 |         |



### PACKAGING

1 x box = m<sup>3</sup> 0.28  
gross weight - Kg 14

## Finiture \ Finishes

Finiture struttura \  
Frame finishes

Metallo verniciato \ Lacquered metal  

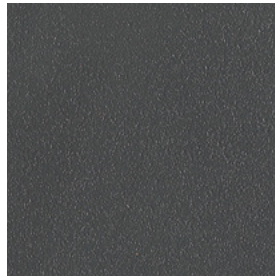

Antracite gofrato \  
Anthracite embossed

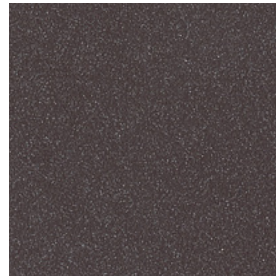

Aval gofrato \  
Aval embossed

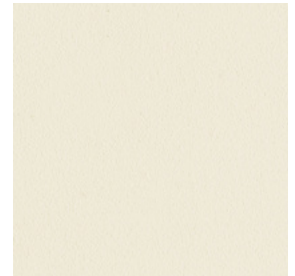

Bianco perla gofrato \  
Pearl white embossed

Finiture schienale \  
Backrest finishes

Iroko \ Iroko  



EU  
Iroko \  
Iroko

Rivestimenti \  
Coverings

Tessuto outdoor \ Outdoor fabric

Collezione outdoor Keel \ Keel outdoor collection

Collezione costituita da sedia e poltroncina dining, poltrona e sgabelli a due altezze. Struttura in tondino d'acciaio verniciato a polveri epossidiche per outdoor nelle finiture antracite, Aval e bianco perla, schienale in massello di iroko. Seduta imbottita in poliuretano espanso ignifugo. Rivestimenti di collezione.

Collection consisting of dining chair and armchair, armchair and stools in two heights. Structure in anthracite, Aval or pearl white embossed steel rod for outdoor, backrest in solid iroko wood. Upholstered seat in fire retardant polyurethane foam. Coverings as per collection.

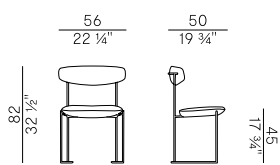

922-OUT  
sedia dining \ dining chair

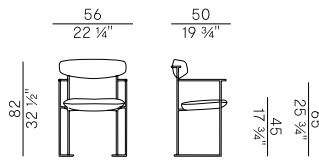

922/P-OUT  
poltroncina dining \ dining armchair

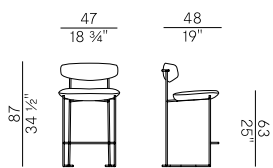

922/S-OUT  
sgabello basso \ counterstool

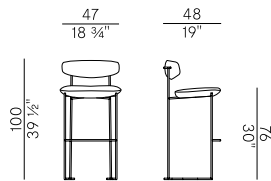

922/A-OUT  
sgabello alto \ barstool

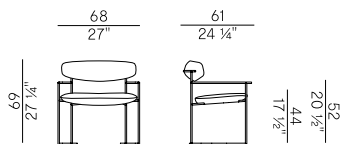

922/L-OUT  
poltrona \ armchair