

# THOMAS

Design: Maurizio Manzoni



## Product description

Upholstered bed covered in synthetic leather, fabric, micro nubuck or soft leather as per sample card. With bronze (GFM18) or graphite (GFM69) embossed lacquered steel feet. Provided slats are part of the bed structure.

# THOMAS

Design: Maurizio Manzoni

## Dimension

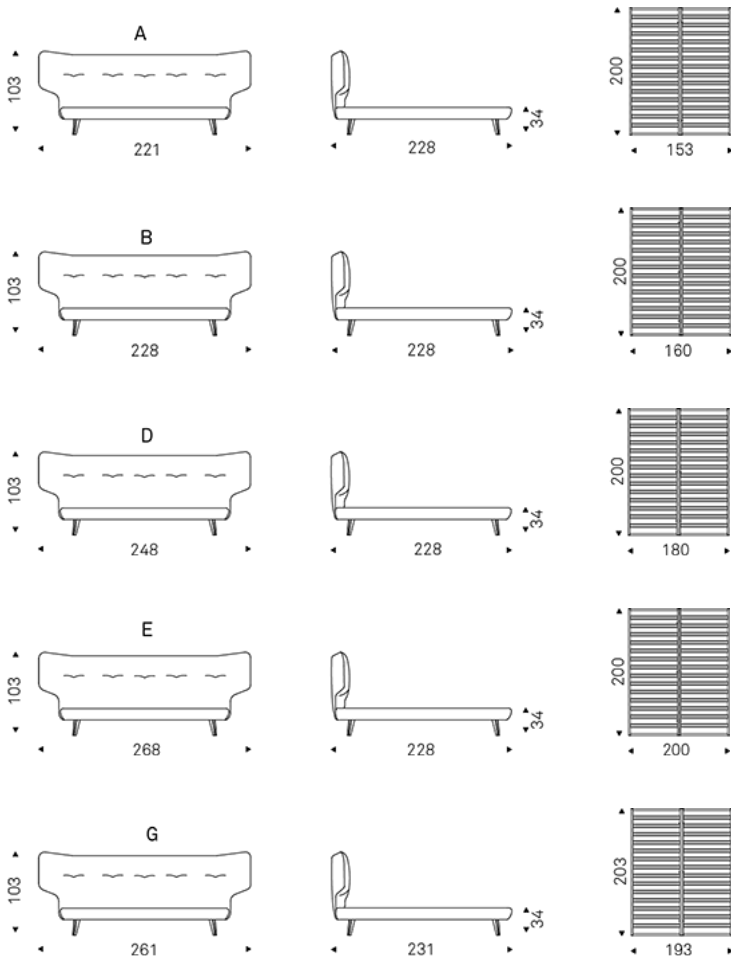

## THOMAS

Design: Maurizio Manzoni

Finishes: upholster

*soft leather*

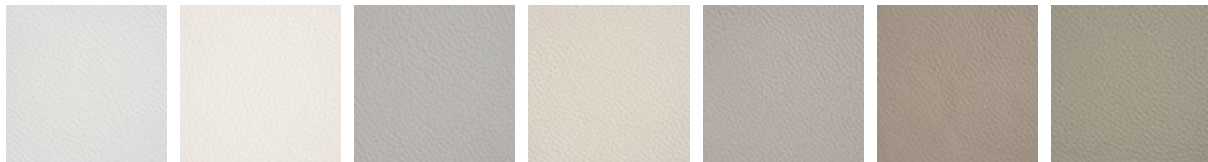

971 BIANCO

937 PALLADIO

972 CANOVA

947 OYSTER

959 ICE

939 NYMPH

949 CENERE

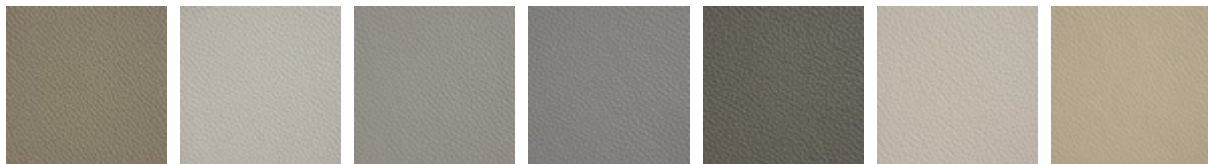

951 CASTORO

993 ARTICO

938 DAKOTA

995 NARDÒ

983 ARGILLA

948 LINO

969 CASHMERE

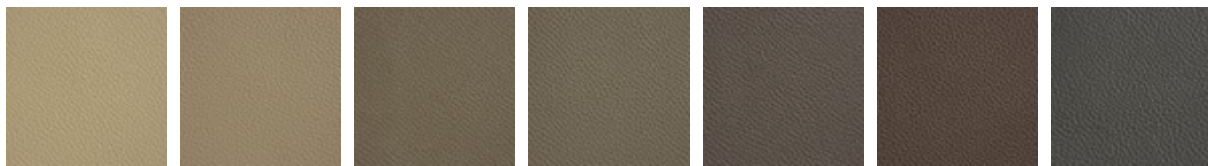

945 SAFARI

950 TORTORA

960 BRUNO

942 FANGO

946 MARRONE

988 TABACCO

952 SMOKE

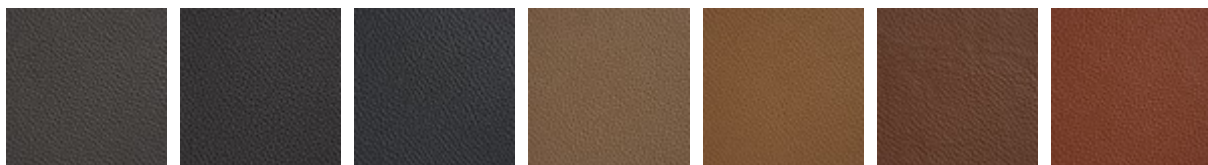

953 ARDESIA

977 PIOMBO

956 ATLANTICO

981 BISCOTTO

982 COGNAC

996 SIENA

994 CANYON

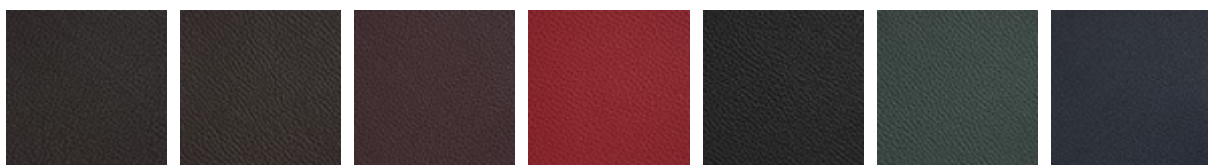

943 MOKA

891 TESTA DI  
MORO

944 BORDEAUX

989 ROSSO  
CORSA

973 NERO

987 SHERWOOD

940 NAVY

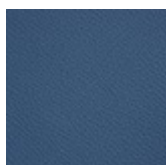

974 CAPRI



*fabric*

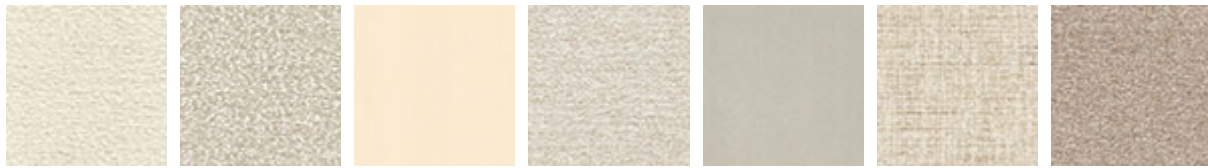

B240 B241 B920 B730 B921 B610 B732

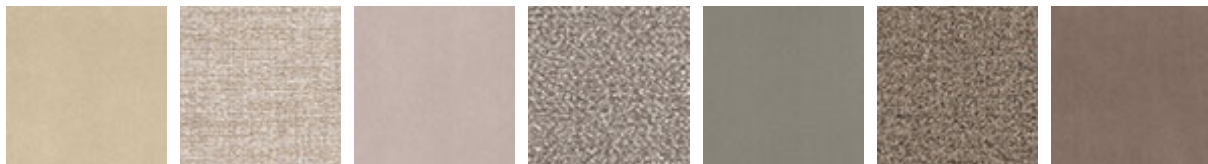

B922 B810 B923 B242 B924 B731 B925

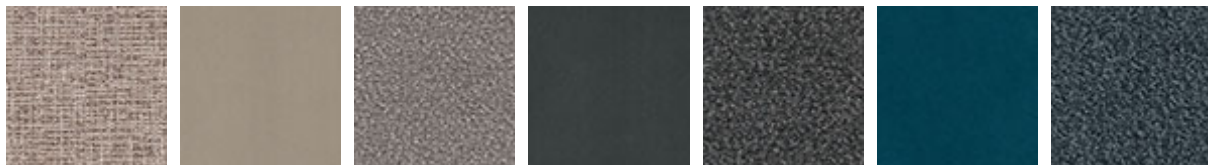

B811 B926 B243 B927 B244 B928 B245

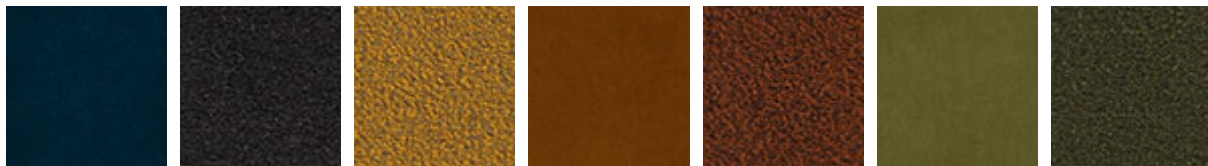

B929 B246 B247 B930 B248 B931 B249



B932 B714 B713 B520 B530 B401 B721



B720 B722 B403 B420 B521 B710 B711



B540 B522 B541 B531 B421 B220 B221

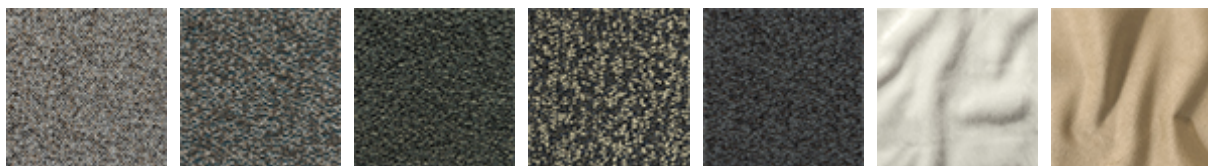

B222 B431 B433 B434 B435 B230 B231



B232      B233      B234      B235      B236      B238      B239



B405      B422      B712

## *synthetic leather*



ECP01 BIANCO      ECP72 CANOVA      ECP47 OYSTER      ECP48 LINO      ECP25 CANAPA      ECP05 TORTORA      ECP26 FANGO



ECP83 ARGILLA      ECP07 MARRONE  
ECP27 FOSSIL      ECP08 MOKA      ECP28 KALAMATA      ECP36 CEMENTO      ECP23 LONDON

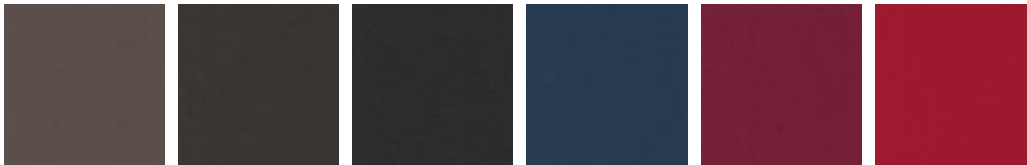

ECP37 ARDESIA      ECP30 PIOMBO      ECP24 NERO      ECP22 NAVY      ECP14 BORDEAUX      ECP13 ROSSO  
CORSA

## *micro nubuck*



MN103 WHITE      MN100 BEIGE      MN806 SAND      MN604 SHADOW      MN006 DUSTY  
ROSE      MN413 ALMOND      MN048  
SUNSTONE



MN709 MINT      MN801 MUSK      MN603 COGNAC      MN609 MARRON      MN618 LEAD      MN626  
CHARCOAL      MN320  
CARDINAL

*glove soft leather*



GLV02 DOVER

GLV03 ECRÙ

GLV05 CORDA

GLV06 MANTA

GLV07 ARGO

GLV11 TAUPE

GLV14 PLATOON



GLV15 CARBON

GLV17 HORNET

GLV12 OLIVA

GLV18 BARRIQUE

GLV16 CACAO

Finishes: feet

*metal*

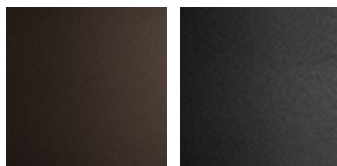

GFM18 bronze  
embossed

GFM69 graphite  
embossed

## GENERAL TERMS AND MAINTENANCE

The **SOFT LEATHER** is a natural material. A non uniformity in the wrinkle's drawing and small defects must be considered a feature that certifies the quality of leather. The leather undergo over time a slight discoloration, either with exposure to direct sunlight or to sources of heat. Be careful with straps, studs, buttons or other sharp metal objects that could scar the surfaces.

**MAINTENANCE:** It is a good practice to remove the dust, which often clogs the pores, not allowing the natural perspiration. Always use a soft, dry cloth. Avoid using brushes that can damage the surface. The removal of stain is extremely difficult as in the case of grease spots, ink and alcohol. Good results can be obtained by acting promptly with soapy water or mild detergent, rinse and wipe dry immediately with a soft cloth. Avoid alcohol, acetone, trichlorethylene, detergents or abrasives.

**CATTELAN ITALIA LEATHERS** are produced with selected cow leathers, tanned and dyed with products that do not contain substances harmful to human health, in full compliance with the current regulations.

**MAINTENANCE:** see the instructions for the soft leather.

The **SYNTHETIC LEATHER, SYNTHETIC NUBUCK and MICRO NUBUCK** is a special ecological fabric similar to leather or hide even if not realized with animal material. Has excellent physiological and hygienic qualities and is harmless from the toxicological point of view. It does not cause dust allergies. High resilience is finally a good guarantee of durability.

**MAINTENANCE:** requires no special care. In case of stains wipe with a damp cloth. Use neutral specific products. Do not use brushes, grease, petrol or acetone which will damage the surfaces.

**FABRICS** With regard to fiber composition, technical specifications and maintenance instructions, please find information on our website [www.cattelanitalia.com](http://www.cattelanitalia.com) Finishes section.

**PAINT, LACQUER and EMBOSSED PAINT** the main features are light and corrosion resistant. The embossed painting also makes the surface more resistant to scratches, thanks to its grainy film.

**MAINTENANCE:** For normal cleaning, use a slightly damp soft cloth. Do not use abrasive cleaners, solvents, ammonia, acetone. In case of stains, remove them with a solution of mild soap and water, taking care to dry the wet surfaces.

The **WOOD** that is used for all CATTELAN ITALIA products is sourced only from the finest ecologically sustainable forest plantations and each piece has been treated using the least invasive processes as not to affect its natural beauty, but importantly guarantees the longevity and durability over the years of use. Wood is a natural material and as such, it will continue to change in appearance which will further enhance its natural look. Minor variations of tone, the presence of knots, veins and burn marks are all testament to the uniqueness and authenticity that each piece of wood will possess.

**MAINTENANCE:** Please read the care instructions for lacquer.

**LAMINATE** is a material highly resistant to shocks, water, steam, heat, stains, light, and chemical agents.

**MAINTENANCE:** To remove stubborn stains use a damp cloth with water and liquid detergent.

**MARBLE and NATURAL STONES** are protected by a layer of water-oil repellent that protects surfaces. The lead polishing gives to the slab's surface gloss and resistance to light and hard weather conditions, which gives a guarantee of excellent durability.

**MAINTENANCE:** For proper cleaning and surface protection of natural stone or granite use specific products according to their use. Do not use harsh detergents that can dull the surface and affect the water-oil repellent treatment. It is advisable to clean, protect and polish only with specific products for natural stone or granite for a long-term durability

The making of the **CERAMIC** used for all CATTELAN ITALIA ceramic tables is an innovative process. It begins with the wet grinding of natural materials such as clay, granite and ceramic particles that are in powder form, which then are all compacted down together in a process known as 'firing'.

**MAINTENANCE:** Ceramic tops should be cleaned with a wet sponge and a mild detergent. Do not use abrasive cleaning products. Do not use a steam cleaner. For best results, it is recommended that you use a limestone cleaning gel. It is best to remove fresh stains as quickly as possible as there is the potential risk that over time the stain can penetrate the pores of the ceramic. In the event that a stain has been present on the ceramic for some time, use a solution mixed from bicarbonate soda and water. Rub the surface, allowing the solution to penetrate the stain, and then wipe it off with a wet sponge.

**CLAY** is a thin, multi-layer coating and each layer is applied manually with a spatula and naturally dried. The processing is completed with a last protective coating to preserve the surface and the natural opacity of the material. Natural colours and finishes are the result of soils mixing during the production process of clay and its mixtures. The appearance of imperfections is to be considered as a distinctive feature of the hand-worked material.

**MAINTENANCE:** protect the surface from falling blunt objects, avoid direct contact with flames or very hot objects. For daily cleaning, use a soft cloth with water and mild neutral detergents and dry the surface with a soft cloth or absorbent paper. Remove food residues, liquids or greases within a few hours to avoid permanent stains.

**GLASS, CRYSTALART and MIRRORS**, all glass, tempered or not, have safety features such as to match the requirements.

**MAINTENANCE:** Avoid using abrasive materials that can damage the surface permanently. For the mirrors, it is recommended to use only a soft cloth dampened with alcohol.

**POLYURETHANE** belongs to a large class of compounds called polymers. Polyurethane is made through a process known as 'condensation' which allows the polyurethane to be moulded into any shape. Once the process of condensation is complete and the desired shape has been formed, the end result is that the shaped cannot be unchanged. As a result and by using the right elements, the desired requirement of softness and comfort can be met.

**MAINTENANCE:** For normal cleaning, use a damp cloth. Do not use abrasive cleaning products such as ammonia or solvents. To remove spots, use a solution mixed from water and mild soap and ensure that you dry the affected area immediately after wiping it.



## INSTRUCTIONS

If you must assemble components, follow all instructions included in the packaging. Screws, bolts and other fastening parts should preferably be tightened by hand. Do not use power tools. In case of difficulty, please contact your dealer for any assistance. Do not use the product for uses other than those related to the category it belong.

## DISPOSAL

After use do not dispose of the furniture in the environment. Entrust to specialized companies for the recovery and / or disposal.

## WARRANTY

This Certificate of Guarantee apply to all CATTELAN ITALIA products, and is valid only in cases where the item purchased is defective or fails to fulfil compliance to the objective descriptions and aspects of quality and performance made by the seller or the producer. The warranty applies to the product up to 2 years after delivery. The warranty is supplied at the moment of the sale and is valid only in the presence of data and stamp of the dealer, the bill of lading or receipt. The warranty is valid only for defects of conformity existing at the delivery thereof and excludes any other type of defect source later if not objectively recognized. Are also excluded from application of the Warranty Certificate the following aspects: transport damage, damage or breakdown products as a result of improper handling and / or storage at the warehouse store or distributor, faults and deterioration from use, scratches and abrasions, stains, exposure to water, direct sunlight, excessive heat or cold, vandalism, misuse, misapplication and / or incorrect use of the product, improper handling of materials. Are also excluded from the guarantee products made from materials supplied by the customer and tampering or attempted repair of the goods without written permission by CATTELAN ITALIA

*These information are based on data published in our latest online pricelist. Cattelan Italia reserves the right to change or improve any product without any notice.*