

Vetra

Un mobile concepito come una struttura architettonica, passando attraverso volumi semplici, compatti, solidi. La base monolitica forma il principale sostegno degli elementi contenitori, con ante o cassettoni. I singoli moduli, disponibili in tre larghezze, si prestano a un gioco di incastri nel basamento, e possono essere posizionati liberamente lungo i piani di appoggio, insieme anche a due diverse dimensioni di cuscini cilindrici, per creare composizioni versatili, in risposta a esigenze sia funzionali sia estetiche.

Vetra is a piece of furniture conceived as an architectural structure, that is built through simple, compact, and solid volumes. The monolithic base forms the main support of the storage elements, with doors or drawers. These separate units, which come in three widths, can be freely positioned along the base, combined also with two different sizes of cylindrical cushions, to form a variety of compositions that meet both practical and aesthetic needs.

42, 43

SKETCHES OF CONFIGURATIONS

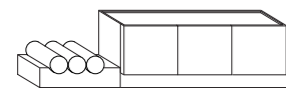

- 1 - basamento 80 - base 80
- 1 - basamento 160 - base 160
- 1 - contenitore centrale 150 - central storage unit 150
- 1 - cuscino 3 cilindri - cushion 3 bolsters

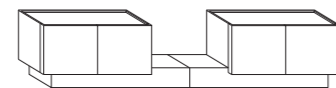

- 2 - basamento 150 - base 150
- 1 - contenitore terminale sx 100 - left end unit storage unit 100
- 1 - contenitore terminale dx 100 - right end unit storage unit 100



- 2 - basamento 150 - base 150
- 2 - contenitore centrale 100 - central storage unit 100

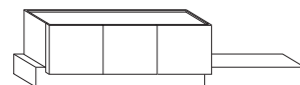

- 1 - basamento 150 - base 150
- 1 - basamento 100 - base 100
- 1 - contenitore centrale 150 - central storage unit 150



- 4 - basamento 100 - base 100
- 2 - contenitore centrale 100 - central storage unit 100



44, 45



TECHNICAL DETAILS

IT

- basamenti e contenitori modulari componibili
- struttura basamenti e contenitori non affiancabili in legno
- finiture basamenti: lacca opaca o lucida impiallacciatura rovere tinto light, black o tobacco rivestimento ottone bronzato, acciaio platinato, acciaio inox o acciaio orbitale (OTB) rivestimento marmo MR1, MR2 o MR3
- finiture contenitori: lacca opaca o lucida impiallacciatura rovere tinto light, black o tobacco
- finiture piani: lacca opaca o lucida impiallacciatura rovere tinto light, black o tobacco vetro retroverniciato nei colori delle lacche marmo MR1, MR2 o MR3 cuscini sfoderabili - optional - in poliuretano e fibre poliestere

Suggerimento stilistico (vincolanti per display):
 - Se basamento e contenitore stessa finitura, piano possibile in tutte le finiture
 - Se basamento finitura diversa da contenitore, piano stessa finitura del contenitore

EN

- modular bases and storage units with wooden frame
- storage units cannot be placed side-by-side
- base finishes: matt or glossy lacquer light, black or tobacco stained oak veneer coated in bronzed brass, platinum steel, stainless steel, orbital steel (OTB) coated in marble MR1, MR2 or MR3
- storage unit finishes: matt or glossy lacquer light, black or tobacco stained oak veneer
- top finishes: matt or glossy lacquer light, black or tobacco stained oak veneer back-painted glass in lacquer colours marble MR1, MR2 or MR3 cushions with removable cover - optional - in polyurethane and polyester fiber

Stylistic suggestions (binding for display):
 - If base and storage unit have same finish, top can be in any finish
 - If base has different finish from storage unit, top should have same finish as storage unit

DE

- Sockel und Modulare Elemente aus Holz
- Elemente sind nebeneinander platzierbar
- Sockel und Elemente aus Holz Ausführungen für Sockel: Lack matt oder Hochglanz Eiche Furnier light, black oder tobacco Messing bronziert, Platinum Steel, Edelstahl oder Stahl mit Orbitalbearbeitung Verkleidung (OTB) Marmorverkleidung MR1, MR2 oder MR3
- Ausführungen für Elemente: Lack matt oder Hochglanz Eiche Furnier light, black oder tobacco
- Ausführungen für Platte: Lack matt oder Hochglanz Eiche Furnier light, black oder tobacco Rücklackiertes Glas in alle Lackfarben Marmor MR1, MR2 oder MR3 Rollenkissen - Extra - aus PU-Schäumen und Polyesterfaser

Stilistische Vorschläge (verbindlich für Platzierungen):
 - wenn Sockel und Elemente in selber Ausführung sind, kann die Platte in jeder Ausführung sein
 - wenn Sockel anderer Ausführung als Element ist, sollte die Platte in selber Ausführung wie Element sein rücklackiertes Glas möglich

FR

- socle et meubles de rangement modulables avec structure en bois les meubles ne peuvent pas être placés côte à côte
- finitions socles: laque mate ou brillante placage de chêne teinté light, black ou tobacco couverture en laiton bronzé, platinum steel, acier inoxydable, acier orbital (OTB) couverture en marbre MR1, MR2 ou MR3
- finitions meubles de rangement: laque mate ou brillante placage de chêne teinté light, black ou tobacco
- finitions plateaux: laque mate ou brillante placage de chêne teinté light, black ou tobacco verre retro-laqué dans les couleurs de laque marbre MR1, MR2 ou MR3 coussins déhoussables - optional - en polyuréthane et fibre polyester

Suggestions stylistiques (obligatoires pour implantation):
 - Si base et meuble ont la même finition, le plateau peut être dans toutes finitions.
 - Si la base a une finition différente de celle du meuble, le plateau doit avoir la même finition que le meuble

ES

- bases y unidades modulares con estructura de madera las unidades no se pueden poner uno junto al otro
- acabados bases: laca mate o brillo enchapado de roble teñido light, black o tobacco revestido de latón bronceado, platinum steel, acero inoxidable, acero orbital (OTB) revestido de mármol MR1, MR2 o MR3
- acabados unidades: laca mate o brillo enchapado de roble teñido light, black o tobacco
- acabados sobres: laca mate o brillo enchapado de roble teñido light, black o tobacco vidrio retrobarnizado en los colores de laca mármol MR1, MR2 o MR3 cojines desenfundables - opcional - en poliuretano y fibra poliéster

Sugerencias estilísticas (vinculantes para exhibición):
 - Si base y unidad tienen el mismo acabado, el sobre puede ser en cualquier acabado
 - Si la base tiene un acabado diferente al de la unidad, el sobre debe tener el mismo acabado que la unidad

contenitore 50 - storage unit 50

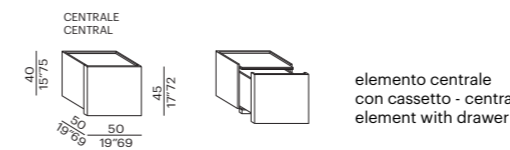

contenitore 100 - storage unit 100

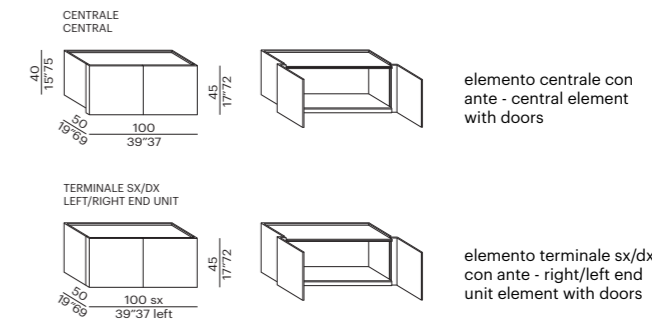

contenitore 100 - storage unit 100

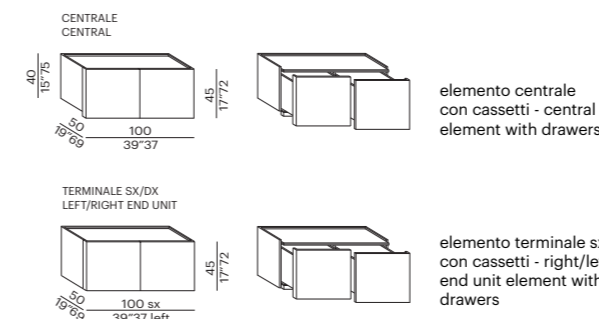

contenitore 150 - storage unit 150

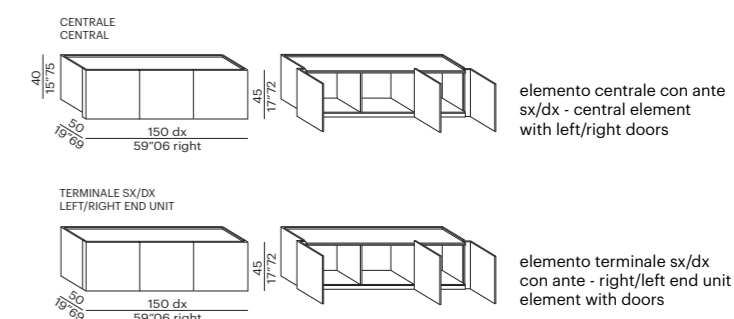

contenitore 150 - storage unit 150

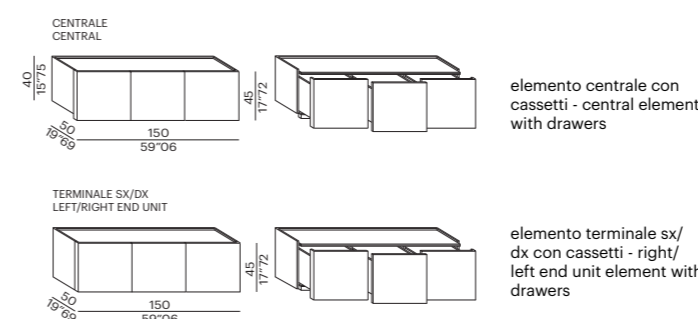

basamento 80 - base 80

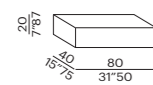

basamento 100 - base 100

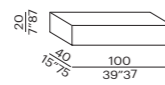

basamento 150 - base 150

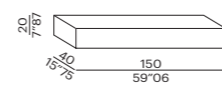

basamento 160 - base 160

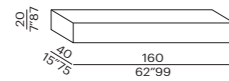

cuscino 3 cilindri - cushion 3

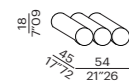

cuscino 4 cilindri - cushion 4

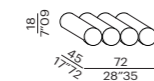

piano 50 - top 50

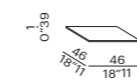

piano 100 - top 100

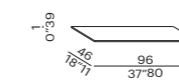

piano 150 - top 150

