



Struttura: in legno multistrato di vari spessori.

SUITE: preparazione della struttura sedile in poliuretano espanso a quote differenziate ad alta densità, realizzata con sede concava per accogliere il cuscino sedile favorendone la durata grazie alla sua reversibilità.

SPRING: preparazione della struttura sedile in poliuretano espanso a quote differenziate ad alta densità con inserto centrale composto da molle d'acciaio insacchettate che garantiscono l'indeformabilità della seduta e un maggiore confort (le panche con profondità 52 e 39 cm hanno un molleggio garantito da cinghie elastiche ad alta componente di caucciù).

Braccioli e schienali realizzati in legno multistrato di differenti spessori, rivestiti con poliuretano espanso a quote differenziate ad alta densità. Braccioli e schienali rivestiti con trapuntino di fibra termolegata traspirante accoppiata con tela di cotone bianca anallergica che conferisce morbidezza e sofficià. Bracciolo AMOVIBILE con struttura in MDF e imbottitura in poliuretano espanso a quote differenziate ad alta densità, successivamente rivestito con fibra termolegata traspirante e ulteriore strato di piuma d'oca canalizzata, sottoposta a regolare trattamento di bonifica igienico-sanitaria come stabilito dal Regolamento CE 1069/2009 (certificata Assopiuma, Etichetta Oro), accoppiata con tela di cotone bianca. Le fodere dello schienale e dei braccioli LOW e HIGH degli elementi SUITE, così come le fodere del sedile, dello schienale e dei braccioli LOW e HIGH degli elementi SPRING, prevedono una trapuntatura realizzata grazie ad un ricamo lineare che accoppia la fibra termolegata di forte spessore con la tela di cotone bianco, alla fodera.

Il motivo longitudinale enfatizza la modernità del volume.

Case: il sistema di sedute propone elementi attrezzati con tavolini contenitore disponibili nelle seguenti finiture:

- struttura esterna in MDF laccato lucido nei colori Ghiaccio, Cappuccino e Moka, accoppiata ad una struttura interna in alluminio satinato e verniciato color Brandy;
- struttura esterna in MDF impiallacciato palissandro Santos* tinto Dark Brown, laccato poliestere opaco, accoppiata ad una struttura interna in alluminio satinato e verniciato color Brandy;
- struttura esterna in MDF impiallacciato frassino laccato a poro aperto Nero, accoppiata ad una struttura interna in alluminio satinato e verniciato color Brandy.

Cuscinatura: imbottitura cuscini schienali e sedile in piuma d'oca canalizzata, sottoposta a regolare trattamento di bonifica igienico-sanitaria come stabilito dal Regolamento CE 1069/2009 (certificata Assopiuma, Etichetta Oro) con inserto in poliuretano a quote differenziate ad alta resilienza rivestito da un ulteriore strato di Memory Foam. Cuscini sedile completamente reversibili (SUITE).

Structure: in plywood of various thicknesses.

SUITE: structure seat made of high-resilience, variable-density polyurethane foam with concave contour to accommodate the seat cushion and promote long lifetime. It is reversible.

SPRING: seat structure in high-resilience, variable-density polyurethane foam with core insert made of steel pocket springs to ensure the seat maintains its shape and a greater comfort (the benches in 52 and 39 cm depth have a suspension provided by high-rubber-content elastic webbing).

Armrests and backrests in plywood of various thicknesses, coated in high-resilience, variable-density polyurethane foam.

Armrests and backrests covered in breathable heat-bonded quilted fibre casing laminated to white hypoallergenic cotton fabric for added fluffy softness.

REMOVABLE armrest with structure in MDF and high resilience variable-density polyurethane foam padding, then covered with breathable, heat-bonded fibre and an additional layer of channelled goose down and undergo routine sanitization as specified in EC Regulation No. 1069/2009 (Assopiuma Gold Label certified), laminated to white cotton fabric.

The backrest and LOW/HIGH armrest upholstery of the SUITE elements, as well as the seat, backrest and LOW/HIGH armrest upholstery of the SPRING elements, are tailored with a linear quilted motif that joins the thick heat-bonded fibre and the white cotton fabric to the upholstery. The longitudinal pattern highlights the modern contours.

Case: the seating system features pieces equipped with storage coffee tables available in the following finishes:

- external structure in MDF with glossy lacquer finish in Ice, Cappuccino and Moka colour, laminated to an internal structure in varnished satin-finish Brandy colour aluminium;
- external structure in MDF with palissander Santos* veneer, stained Dark Brown, matt polyester lacquer finish, laminated to an internal aluminium structure with varnished Brandy colour satin finish;
- external structure in MDF open-pore Black lacquered ash veneer, laminated to an internal aluminium structure with varnished Brandy colour satin finish.

Cushions: backrest and seat cushions are in channelled goose down and undergo routine sanitization as specified in

EC Regulation No. 1069/2009 (Assopiuma Gold Label certified) with insert in high resilience, variable-density polyurethane foam covered with an additional layer of Memory Foam. Seat cushions are completely reversible (SUITE).

Gestell: aus Sperrholz verschiedener Stärken.

SUITE: Polsterung des Gestells der Sitzfläche aus PU-Schaum mit differenzierter, hoher Dichte, hergestellt mit vertieftem Sitz zur Aufnahme des Sitzkissens, was die Haltbarkeit aufgrund seiner Wendbarkeit begünstigt.

SPRING: Polsterung des Gestells der Sitzfläche aus PU-Schaum mit differenzierter, hoher Dichte, mit zentralem Einsatz aus Taschenfederkernen aus Stahl, die die Unverformbarkeit des Sitzes und einen besseren Komfort garantieren (die Bänke mit 52 und 39 cm Tiefe haben eine garantierte Federung durch elastische Riemen mit hohem Kautschukanteil).

Armlehnen und Rückenlehnen aus Sperrholz mit unterschiedlicher Stärke, Polsterung aus PU-Schaum mit differenzierter, hoher Dichte. Armlehnen und Rückenlehnen mit gesteppter Polsterung aus atmungsaktiver, thermobondierter Faser mit Bezug aus weißer, antiallergischer Baumwolle für einen angenehmen weichen Sitzkomfort.

ABNEHMBARE Armlehne mit Gestell aus MDF und Polsterung aus PU-Schaum mit hoher, differenzierter Dichte, anschließend mit atmungsaktiver, thermobondierter Faser mit zusätzlicher Daunenfüllung mit Kammern und Innenstegen und Sterilisierung der Füllung nach Vorgabe der Verordnung (EU) 1069/2009 (zertifiziert Assopiuma, "Goldenes Etikett") kombiniert mit weißem Bezug aus Baumwolle.

Die Bezüge der Rückenlehne und der LOW und HIGH Armlehnen der SUITE-Elemente sowie die Bezüge der Sitzfläche, der Rückenlehne und der LOW und HIGH Armlehnen der SPRING-Elemente weisen eine lineare Steppung auf, die die dicke, heißverfestigte Faser und den weißen Baumwollstoff mit dem Bezug verbindet. Das Längsschnittmuster unterstreicht die Modernität der Größe.

Case: das Sitzsystem verfügt über Elemente, die mit Beistelltisch mit Fach ausgestattet sind, die in folgenden Ausführungen verfügbar sind:

- Außenseite aus MDF, glänzend lackiert in den Farben Eis, Cappuccino und Moka, kombiniert mit einer internen Struktur aus satiniertem Aluminium, lackiert in der Farbe Brandy;
- Außenseite aus MDF, furniert mit Palissander Santos* Dark Brown gebeizt, mit matter Polyesterlackierung, kombiniert mit einer internen Struktur aus satiniertem Aluminium, lackiert in der Farbe Brandy;
- Außenseite aus MDF, furniert offenporig lackiertem Eschenholz in der Farbe Schwarz, kombiniert mit einer internen Struktur aus satiniertem Aluminium, lackiert in der Farbe Brandy.

Kissen: Rückenkissen und Sitzkissen mit gesteppter Daunenfüllung mit Kammern und Innenstegen und Sterilisierung der Füllung nach Vorgabe der Verordnung (EU) 1069/2009 (zertifiziert Assopiuma, "Goldenes Etikett"), mit Kern aus hochwiderstandsfähigem PU-Schaum mit differenzierter Dichte, mit einer zusätzlichen Schicht aus Memory Foam überzogen.

Structure: en multiplis de différentes épaisseurs.

SUITE: préparation de la structure du siège en mousse de polyuréthane à densité différenciée haute résilience, réalisée avec un logement concave pour accueillir le coussin d'assise, favorisant ainsi la durabilité grâce à sa réversibilité.

SPRING: préparation de la structure du siège en mousse de polyuréthane à densité différenciée haute résilience avec un insert central composé de ressorts en acier ensachés qui assurent l'indéformabilité de l'assise et un plus grand confort (les bancs avec profondeur 52 et 39 cm ont une suspension assurée par des sangles élastiques à haute teneur en caoutchouc).

Accoudoirs et dossiers en multiplis de différentes épaisseurs, recouverts de mousse de polyuréthane à densité différenciée haute résilience. Accoudoirs et dossiers recouverts d'un tissu contrecollé en toile de coton blanc hypoallergénique collée à de la fibre thermoliée respirante qui apporte de la souplesse et du moelleux.

Accoudoir AMOVIBLE avec structure en MDF et rembourrage en mousse de polyuréthane à densité différenciée haute résilience, recouvert ensuite de fibre thermoliée respirante et d'une couche supplémentaire en plume d'oie cloisonnée, soumise à un traitement d'assainissement conformément au règlement CE 1069/2009 (Certifiée Assopiuma, Label Or), collée à du tissu en coton blanc. Les housses du dossier des accoudoirs LOW et HIGH des éléments SUITE, ainsi que les housses de l'assise, du dossier et des accoudoirs LOW et HIGH des éléments SPRING, présentent un matelassage réalisé grâce à une broderie linéaire qui assemble la fibre thermo-liée de forte épaisseur et la toile de coton blanc à la housse. Le motif longitudinal souligne la modernité du volume.

Case: ce système de sièges propose des éléments équipés de petite table récipient, disponibles dans les finitions suivantes:

- structure externe en MDF laqué brillant couleur Glace, Cappuccino ou Moka, contrecollée sur une structure interne en aluminium satiné et peint couleur Brandy;
- structure externe en MDF plaqué palissandre de Santos* teinté Dark Brown, laqué polyester mat, contrecollée sur une structure interne en aluminium satiné et peint couleur Brandy;
- structure externe en MDF plaqué frêne laqué Noir à pores ouverts, contrecollée sur une structure interne en aluminium satiné et laqué couleur Brandy.

Coussins: rembourrage des coussins de dossier et d'assise en plume d'oie cloisonnée, soumise à un traitement d'assainissement conformément au règlement CE 1069/2009 (Certifiée Assopiuma, Label Or) avec insert en polyuréthane à densité différenciée haute résilience recouvert d'une couche de mousse à mémoire de forme. Coussins d'assise entièrement réversibles (SUITE).

Minotti

Sfoderabilità: cuscini sedile e schienale completamente sfoderabili in tutte le versioni (tessuto e pelle). Rivestimento della struttura in tessuto o pelle sfoderabile.

Per facilitare la sfoderabilità degli schienali angolari, alti e bassi, è stata posizionata una cerniera nella parte interna, in prossimità dell'angolo.

Base: cornice perimetrale in estruso di alluminio con elementi di giunzione in alluminio pressofuso, entrambe verniciati lucido anti-touch color Black Coffee. Appoggio a terra tramite lame portanti in estruso di alluminio, verniciato lucido anti-touch color Black Coffee. Scivolante in polietilene antimacchia oil free.

Prima di procedere alla rimozione del rivestimento, svitare i vari elementi (braccioli e schienali) dalla base.

AVVERTENZE SULLA CONFEZIONE IN PELLE/ALCANTARA/VELLUTO

Le fodere realizzate in pelle, Alcantara o velluto presentano delle cuciture verticali supplementari sullo schienale (SUITE/SPRING) e sul sedile (SPRING) che interrompono il ricamo lineare che segna la trapuntatura.

Tessuti non disponibili per questo prodotto: Check, Kabuki, Kita Big / Small, Kita Chevron, Kolly, Leopold, Mosaic, Tibet Pixel, Tibet Square, Tokyo, Twill Large / Small, Zebra.

* il palissandro Santos deriva da foreste correttamente gestite.

CUSCINO "MIRAGE"

Cuscino con imbottitura 100% piuma d'oca canalizzata, sottoposta a regolare trattamento di bonifica igienico-sanitaria come stabilito dal Regolamento CE 1069/2009 (certificata Assopiuma, Etichetta Oro) con inserto in poliuretano. Completamente sfoderabile. Rivestimento fronte e retro in tessuto Mirage (con effetto degradé). Il cuscino è reversibile.

CUSCINO "DOUBLE"

Cuscino con imbottitura 100% piuma d'oca canalizzata, sottoposta a regolare trattamento di bonifica igienico-sanitaria come stabilito dal Regolamento CE 1069/2009 (certificata Assopiuma, Etichetta Oro) con inserto in poliuretano. Completamente sfoderabile. Rivestimento del fronte in tessuto con fascia in pelle Aspen o Nabuk. Rivestimento del retro con la medesima pelle della fascia frontale. Il cuscino non è reversibile.

Covers: seat and backrest cushions are completely removable in all versions (fabric and leather). The structure is upholstered in removable fabric or leather. Removable upholstery of the high and low corner backrests is facilitated by a zipper placed on the internal part near the corner.

Base: extruded aluminium perimeter frame with cast aluminium joint fittings, varnished polished anti-fingerprint Black Coffee colour. Rests on weight-bearing blades in extruded aluminium, varnished polished anti-fingerprint Black Coffee colour. Oil-free, non-staining polyethylene glides.

Before removing the upholstery, unscrew the various parts (armrests and backrests) from the base.

IMPORTANT NOTICE ABOUT UPHOLSTERY IN LEATHER/ALCANTARA/VELVET

Upholstery made of leather, Alcantara or velvet has additional vertical stitching along the backrest (SUITE/SPRING) and on the seat (SPRING) that interrupts the linear embroidered quilting motif.

Fabrics not available for this product: Check, Kabuki, Kita Big / Small, Kita Chevron, Kolly, Leopold, Mosaic, Tibet Pixel, Tibet Square, Tokyo, Twill Large / Small, Zebra.

* palisander Santos comes from properly managed forests.

"MIRAGE" CUSHION

Cushion with 100% channeled goose down padding undergo routine sanitization as specified in EC Regulation No. 1069/2009 (Assopiuma certified, Gold Label) with polyurethane insert. Completely removable upholstery. Front and back upholstery in Mirage fabric (with subtle shading effect). Cushion is reversible.

"DOUBLE" CUSHION

Cushion with 100% channeled goose down padding undergo routine sanitization as specified in EC Regulation No. 1069/2009 (Assopiuma certified, Gold Label) with polyurethane insert. Completely removable upholstery. Front upholstery is in fabric with strip in Aspen leather or Nabuk. Back is upholstered in the same leather as the front strip. The cushion is not reversible.

Die Sitzkissen sind vollständig wendbar (SUITE).

Abziehbarkeit: Sitzkissen und Rückenkissen sind in allen Versionen (Stoff oder Leder) komplett abziehbar. Der Stoffbezug oder Lederbezug der Struktur ist komplett abziehbar. Um das Abziehen der Bezüge von den hohen und niedrigen Eck-Rückenlehnen zu erleichtern, wurde ein Reißverschluss an der Innenseite in der Nähe der Ecke angebracht.

Basis: Gestellrahmen aus extrudiertem Aluminium mit Verbindungselementen aus Aluminiumdruckguss, mit glänzender Anti Touch-Oberfläche in der Farbe Black Coffee lackiert.

Tragender Kufenfuß aus extrudiertem Aluminium mit glänzender Anti Touch-Lackierung in der Farbe Black Coffee.

Gleiter aus Polyethylen mit ölfreier Fleckenschutzbehandlung. Vor dem Entfernen der Bezüge, zunächst die verschiedenen Elemente (Armlehnen und Rückenlehnen) von dem Unterbau abschrauben.

HINWEIS ZUR KONFEKTIONIERUNG MIT LEDER/ALCANTARA/SAMT

Bezüge aus Leder, Alcantara oder Samt weisen zusätzliche vertikale Nähte auf der Rückseite (SUITE/SPRING) und dem Sitz (SPRING) auf, diese unterbrechen die lineare Stickerei, die die Steppung kennzeichnet.

Für dieses Produkt nicht verfügbare Stoffe: Check, Kabuki, Kita Big / Small, Kita Chevron, Kolly, Leopold, Mosaic, Tibet Pixel, Tibet Square, Tokyo, Twill Large / Small, Zebra.

* Santos Palisander stammt aus korrekt bewirtschafteten Wäldern.

KISSEN "MIRAGE"

Kissen gepolstert mit 100% kanalisierten Gänsedaunen mit Sterilisierung der Füllung nach Vorgabe der Verordnung (EU) 1069/2009 (Assopiuma-zertifiziert, Gold Label) mit Polyurethan-Einlage. Komplet abnehmbarer Bezug. Vorder- und Rückseite aus Mirage-Stoff (mit Degradé-Effekt). Das Kissen ist wendbar.

KISSEN "DOUBLE"

Kissen gepolstert mit 100% kanalisierten Gänsedaunen mit Sterilisierung der Füllung nach Vorgabe der Verordnung (EU) 1069/2009 (Assopiuma-zertifiziert, Gold Label) mit Polyurethan-Einlage. Komplet abnehmbarer Bezug. Vorderseite aus Stoff mit Aspen- oder Nabuk-Lederband. Rückseite in demselben Leder wie der vordere Band. Das Kissen ist nicht wendbar.

Déhoussage : coussins d'assise et de dossier entièrement déhoussables dans toutes les versions (tissu et cuir). Revêtement de la structure en tissu ou en cuir déhoussable.

Pour faciliter le déhoussage des dossiers d'angle, hauts et bas, une fermeture à glissière a été posée à l'intérieur à proximité de l'angle.

Base : cadre périmétral en aluminium extrudé avec des éléments de jonction en fonte d'aluminium, les deux laqués brillant anti-traces couleur Black Coffee. Appui au sol par des lames de support en aluminium extrudé, laqué brillant anti-traces couleur Black Coffee. Patins glisseurs en polyéthylène antitache sans huile.

Avant de retirer le revêtement, dévisser les différents éléments (accoudoirs et dossiers) du piètement.

REMARQUES CONCERNANT LA CONFECTION EN CUIR/ALCANTARA/VELOURS

Les housses en cuir, Alcantara ou velours arborent des coutures verticales supplémentaires sur le dossier (SUITE/SPRING) et sur l'assise (SPRING) qui interrompent la broderie linéaire marquant le matelassage.

Tissus non disponibles pour ce produit: Check, Kabuki, Kita Big / Small, Kita Chevron, Kolly, Leopold, Mosaic, Tibet Pixel, Tibet Square, Tokyo, Twill Large / Small, Zebra.

* le palissandre de Santos provient de forêts bien gérées.

COUSSIN "MIRAGE"

Coussin garnissage 100% plume d'oie cloisonnée, soumise à un traitement d'assainissement conformément au règlement CE 1069/2009 (certifiée Assopiuma, Label Or) avec insert en polyuréthane. Entièrement déhoussable. Revêtement faces avant et arrière en tissu Mirage (avec effet dégradé). Le coussin est réversible.

COUSSIN "DOUBLE"

Coussin garnissage 100% plume d'oie cloisonnée, soumise à un traitement d'assainissement conformément au règlement CE 1069/2009 (certifiée Assopiuma, Label Or) avec insert en polyuréthane. Entièrement déhoussable. Revêtement face avant en tissu avec bande en cuir Aspen ou Nabuk. Revêtement face arrière dans le même cuir que la bande de la face avant. Le coussin n'est pas réversible.

ELEMENTI CASE | CASE ELEMENTS

BASE
BASE

STRUTTURA ESTERNA
EXTERNAL STRUCTURE

STRUTTURA INTERNA
INTERNAL STRUCTURE

ALLUMINIO LUCIDO
POLISHED ALUMINIUM

LACCATO LUCIDO
GLOSSY LACQUERED

PALISSANDRO SANTOS
PALISANDER SANTOS

FRASSINO
ASH

ALLUMINIO SATINATO
SATIN ALUMINIUM

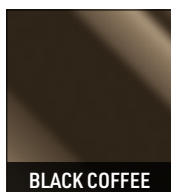

BLACK COFFEE



GHIACCIO
ICE



CAPPUCCINO

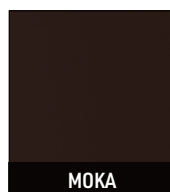

MOKA

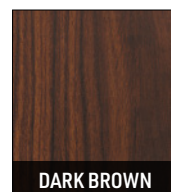

DARK BROWN

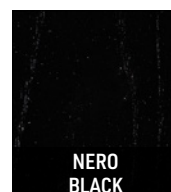

NERO
BLACK



BRANDY

Minotti

ROGER SUITE

DIVANI | SOFAS

SUITE DIVANO LOW CM 250 SUITE SOFA LOW CM 250

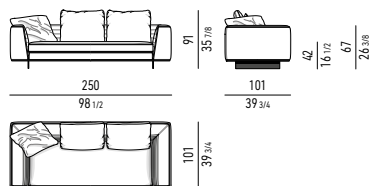

SUITE DIVANO HIGH SQUARE CM 258 SUITE SOFA HIGH SQUARE CM 258

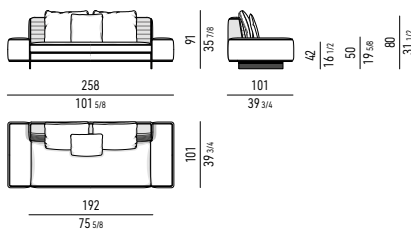

SUITE DIVANO LOW CM 274 SUITE SOFA LOW CM 274

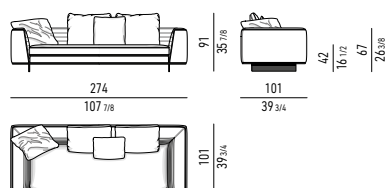

SUITE DIVANO HIGH SQUARE CM 282 SUITE SOFA HIGH SQUARE CM 282

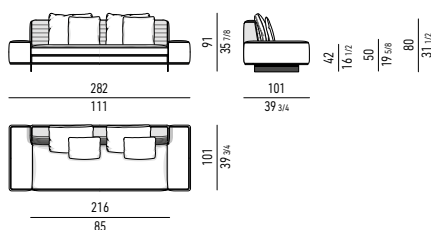

SUITE DIVANO LOW CM 298 SUITE SOFA LOW CM 298

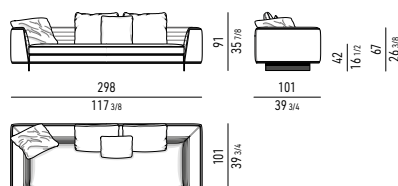

SUITE DIVANO HIGH SQUARE CM 306 SUITE SOFA HIGH SQUARE CM 306

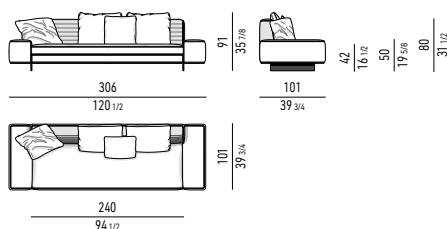

SUITE DIVANO HIGH SQUARE MIX CM 278 SUITE SOFA HIGH SQUARE MIX CM 278

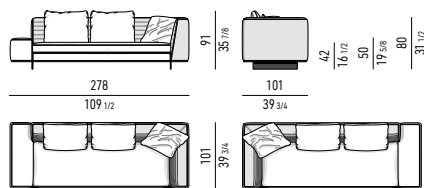

SX

DX

SUITE DIVANO HIGH SQUARE MIX CM 302 SUITE SOFA HIGH SQUARE MIX CM 302

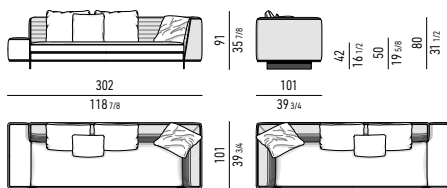

SX

DX

ELEMENTI "CASE" | "CASE" ELEMENTS

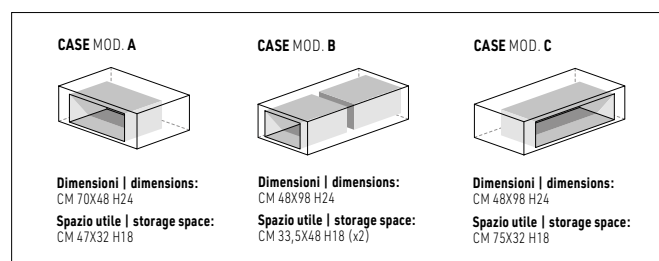

DIVANI-DAYBED | DAYBED-SOFAS

SUITE DIVANO-DAYBED LOW CON CASE CM 274 SUITE DAYBED-SOFA LOW WITH CASE CM 274

CASE MOD. A

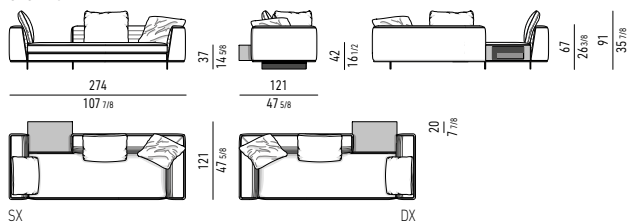

SUITE DIVANO-DAYBED LOW MIX CON CASE CM 274 SUITE DAYBED-SOFA LOW MIX WITH CASE CM 274

CASE MOD. A

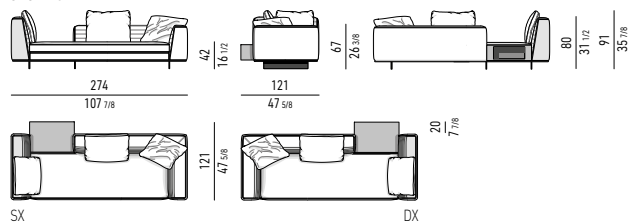

SUITE DIVANO-DAYBED HIGH MIX CON CASE CM 274 SUITE DAYBED-SOFA HIGH MIX WITH CASE CM 274

CASE MOD. A

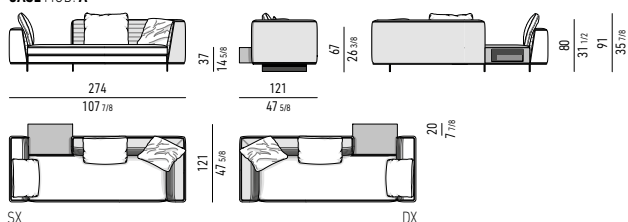

SUITE DIVANO-DAYBED HIGH SQUARE CON CASE CM 278 SUITE DAYBED-SOFA HIGH SQUARE WITH CASE CM 278

CASE MOD. A

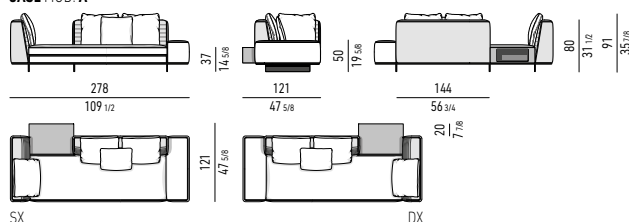

SUITE DIVANO-DAYBED HIGH SQUARE MIX CON CASE CM 278 SUITE DAYBED-SOFA HIGH SQUARE MIX WITH CASE CM 278

CASE MOD. A

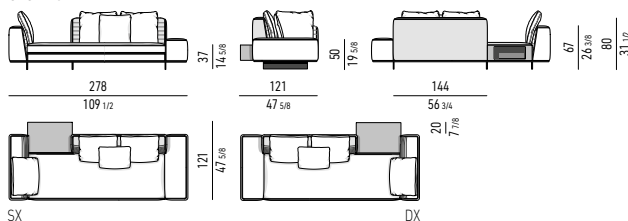

SUITE DIVANO-DAYBED LOW CON CASE CM 298 SUITE DAYBED-SOFA LOW WITH CASE CM 298

CASE MOD. A

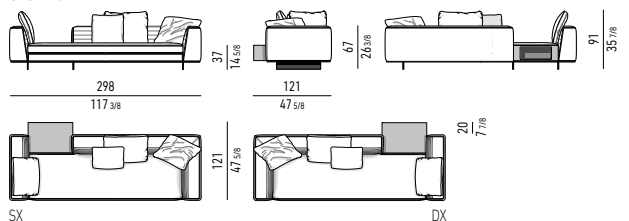

SUITE DIVANO-DAYBED LOW MIX CON CASE CM 298 SUITE DAYBED-SOFA LOW MIX WITH CASE CM 298

CASE MOD. A

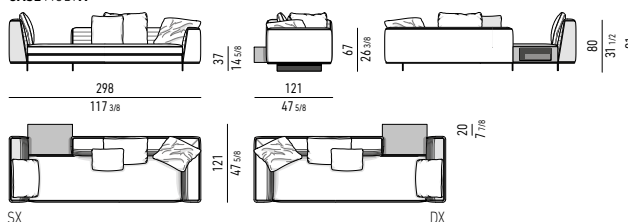

SUITE DIVANO-DAYBED HIGH MIX CON CASE CM 298 SUITE DAYBED-SOFA HIGH MIX WITH CASE CM 298

CASE MOD. A

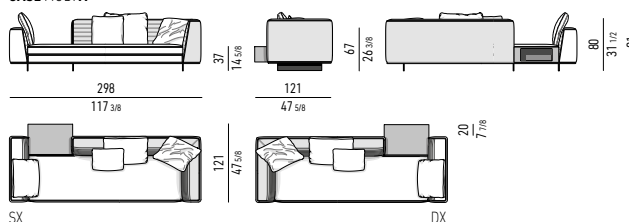

SUITE DIVANO-DAYBED HIGH SQUARE CON CASE CM 302 SUITE DAYBED-SOFA HIGH SQUARE WITH CASE CM 302

CASE MOD. A

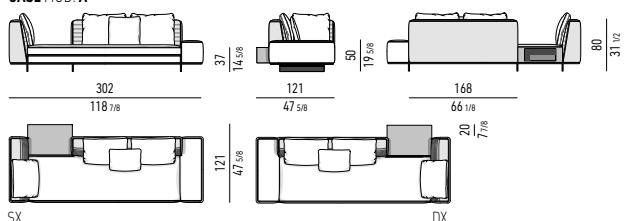

SUITE DIVANO-DAYBED HIGH SQUARE MIX CON CASE CM 302 SUITE DAYBED-SOFA HIGH SQUARE MIX WITH CASE CM 302

CASE MOD. A

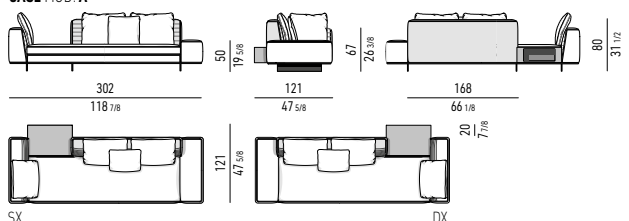

Minotti

ELEMENTI TERMINALI | ELEMENTS WITH 1 ARMREST

SUITE ELEMENTO TERMINALE LOW CM 173
SUITE ELEMENT WITH 1 ARMREST LOW CM 173

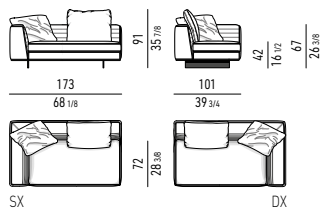

SUITE ELEMENTO TERMINALE HIGH CM 173
SUITE ELEMENT WITH 1 ARMREST HIGH CM 173

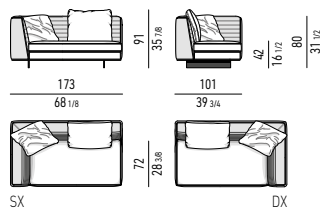

SUITE ELEMENTO TERMINALE HIGH SQUARE CM 177
SUITE ELEMENT WITH 1 ARMREST HIGH SQUARE CM 177

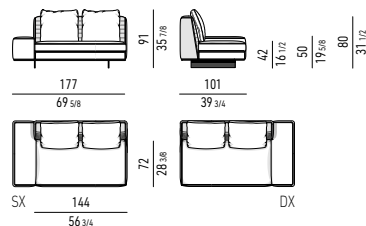

SUITE ELEMENTO TERMINALE LOW CM 197
SUITE ELEMENT WITH 1 ARMREST LOW CM 197

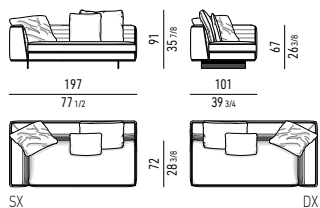

SUITE ELEMENTO TERMINALE HIGH CM 197
SUITE ELEMENT WITH 1 ARMREST HIGH CM 197

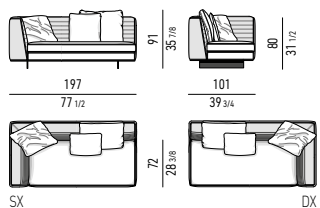

SUITE ELEMENTO TERMINALE HIGH SQUARE CM 201
SUITE ELEMENT WITH 1 ARMREST HIGH SQUARE CM 201

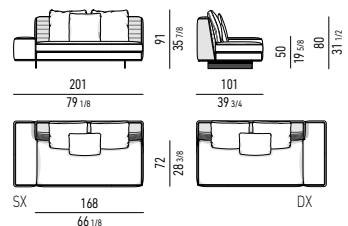

SUITE ELEMENTO TERMINALE LOW CM 221
SUITE ELEMENT WITH 1 ARMREST LOW CM 221

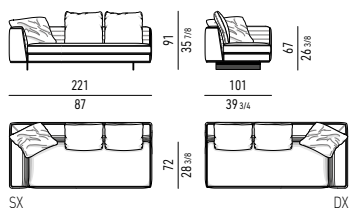

SUITE ELEMENTO TERMINALE HIGH CM 221
SUITE ELEMENT WITH 1 ARMREST HIGH CM 221

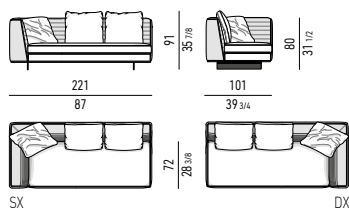

SUITE ELEMENTO TERMINALE HIGH SQUARE CM 225
SUITE ELEMENT WITH 1 ARMREST HIGH SQUARE CM 225

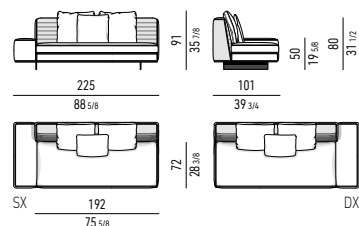

SUITE ELEMENTO TERMINALE LOW CM 245
SUITE ELEMENT WITH 1 ARMREST LOW CM 245

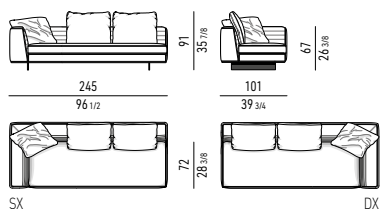

SUITE ELEMENTO TERMINALE HIGH CM 245
SUITE ELEMENT WITH 1 ARMREST HIGH CM 245

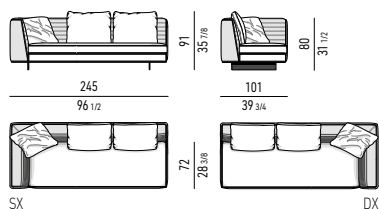

SUITE ELEMENTO TERMINALE HIGH SQUARE CM 249
SUITE ELEMENT WITH 1 ARMREST HIGH SQUARE CM 249

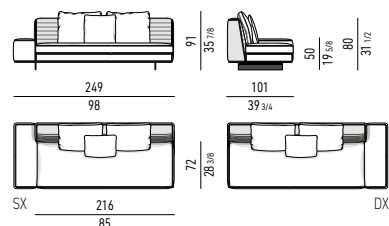

SUITE ELEMENTO TERMINALE LOW CM 269
SUITE ELEMENT WITH 1 ARMREST LOW CM 269

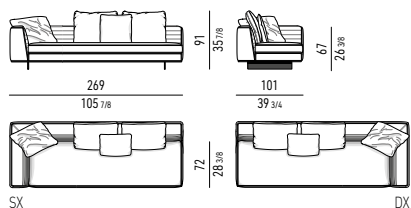

SUITE ELEMENTO TERMINALE HIGH CM 269
SUITE ELEMENT WITH 1 ARMREST HIGH CM 269

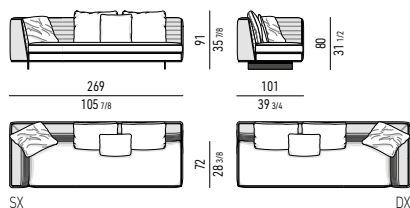

SUITE ELEMENTO TERMINALE HIGH SQUARE CM 273
SUITE ELEMENT WITH 1 ARMREST HIGH SQUARE CM 273

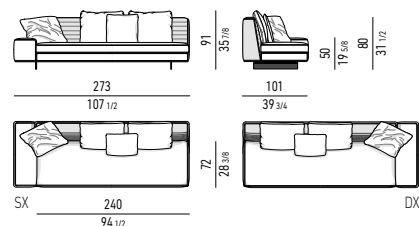

ELEMENTI TERMINALI CON "CASE" | ELEMENTS WITH 1 ARMREST WITH "CASE"

SUITE ELEMENTO TERMINALE LOW CON CASE CM 221 SUITE ELEMENT WITH 1 ARMREST LOW WITH CASE CM 221

CASE MOD. B



CASE MOD. C

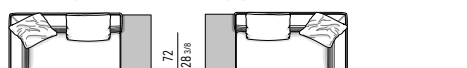
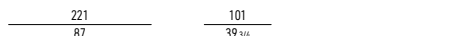

SX

DX

SUITE ELEMENTO TERMINALE HIGH CON CASE CM 221 SUITE ELEMENT WITH 1 ARMREST HIGH WITH CASE CM 221

CASE MOD. B



CASE MOD. C

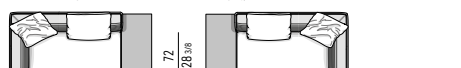
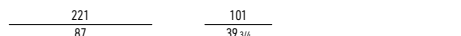

SX

DX

SUITE ELEMENTO TERMINALE HIGH SQUARE CON CASE CM 225 SUITE ELEMENT WITH 1 ARMREST HIGH SQUARE WITH CASE CM 225

CASE MOD. B



CASE MOD. C

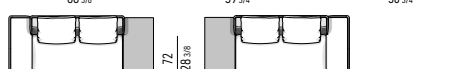
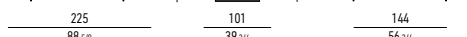

SX

DX

SUITE ELEMENTO TERMINALE LOW CON CASE CM 245 SUITE ELEMENT WITH 1 ARMREST LOW WITH CASE CM 245

CASE MOD. B



CASE MOD. C

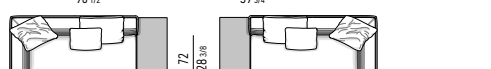
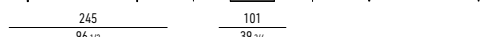

SX

DX

SUITE ELEMENTO TERMINALE HIGH CON CASE CM 245 SUITE ELEMENT WITH 1 ARMREST HIGH WITH CASE CM 245

CASE MOD. B



CASE MOD. C

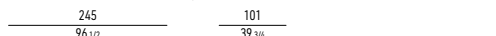

SX

DX

SUITE ELEMENTO TERMINALE HIGH SQUARE CON CASE CM 249 SUITE ELEMENT WITH 1 ARMREST HIGH SQUARE WITH CASE CM 249

CASE MOD. B



CASE MOD. C

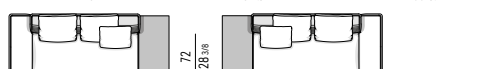
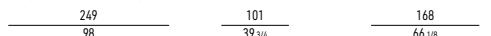

SX

DX

SUITE ELEMENTO TERMINALE LOW CON CASE CM 269 SUITE ELEMENT WITH 1 ARMREST LOW WITH CASE CM 269

CASE MOD. B



CASE MOD. C

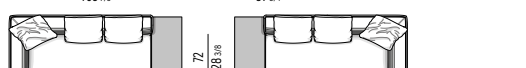
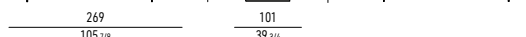

SX

DX

SUITE ELEMENTO TERMINALE HIGH CON CASE CM 269 SUITE ELEMENT WITH 1 ARMREST HIGH WITH CASE CM 269

CASE MOD. B



CASE MOD. C

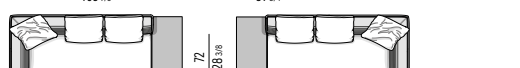
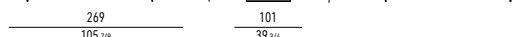

SX

DX

Minotti

SUITE ELEMENTO TERMINALE HIGH SQUARE CON CASE CM 273 SUITE ELEMENT WITH 1 ARMREST HIGH SQUARE WITH CASE CM 273

CASE MOD. B



CASE MOD. C

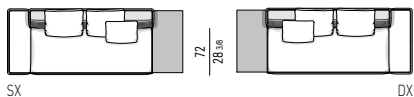
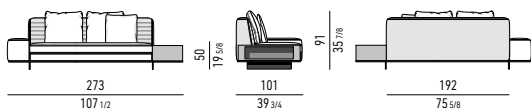

SX

DX

ELEMENTI TERMINALI PENISOLA | OPEN-END ELEMENTS WITH 1 ARMREST

SUITE ELEMENTO TERMINALE PENISOLA LOW CON CASE CM 221 SUITE OPEN-END ELEMENT WITH 1 ARMREST LOW WITH CASE CM 221

CASE MOD. A

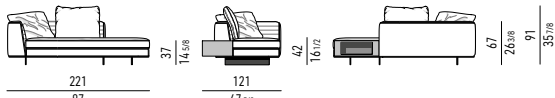

SX

DX

SUITE ELEMENTO TERMINALE PENISOLA HIGH CON CASE CM 221 SUITE OPEN-END ELEMENT WITH 1 ARMREST HIGH WITH CASE CM 221

CASE MOD. A

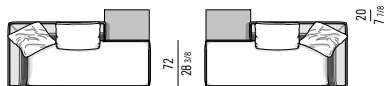
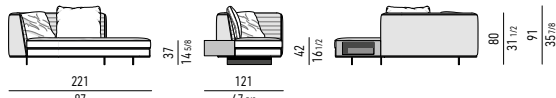

SX

DX

SUITE ELEMENTO TERMINALE PENISOLA HIGH SQUARE CON CASE CM 225 SUITE OPEN-END ELEMENT WITH 1 ARMREST HIGH SQUARE WITH CASE CM 225

CASE MOD. A

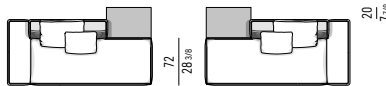
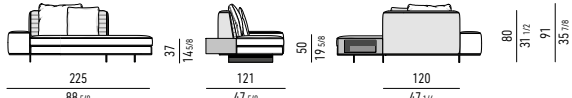

SX

DX

SUITE ELEMENTO TERMINALE PENISOLA LOW CON CASE CM 245 SUITE OPEN-END ELEMENT WITH 1 ARMREST LOW WITH CASE CM 245

CASE MOD. A

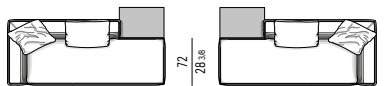
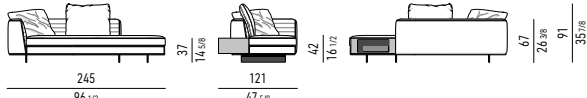

SX

DX

SUITE ELEMENTO TERMINALE PENISOLA HIGH CON CASE CM 245 SUITE OPEN-END ELEMENT WITH 1 ARMREST HIGH WITH CASE CM 245

CASE MOD. A

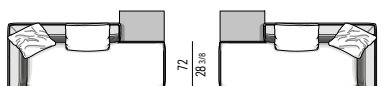
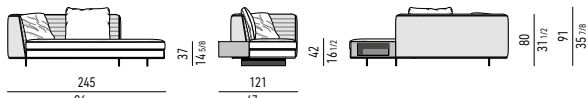

SX

DX

SUITE ELEMENTO TERMINALE PENISOLA HIGH SQUARE CON CASE CM 249 SUITE OPEN-END ELEMENT WITH 1 ARMREST HIGH SQUARE WITH CASE CM 249

CASE MOD. A

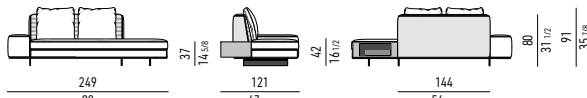

SX

DX

Minotti

SUITE ELEMENTO TERMINALE PENISOLA LOW CON CASE CM 269 SUITE OPEN-END ELEMENT WITH 1 ARMREST LOW WITH CASE CM 269

CASE MOD. A

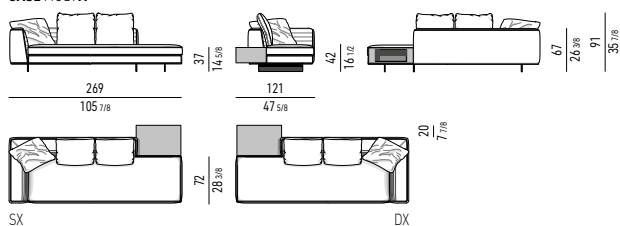

SUITE ELEMENTO TERMINALE PENISOLA HIGH CON CASE CM 269 SUITE OPEN-END ELEMENT WITH 1 ARMREST HIGH WITH CASE CM 269

CASE MOD. A

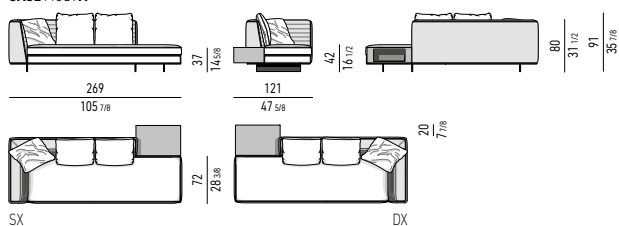

SUITE ELEMENTO TERMINALE PENISOLA HIGH SQUARE CON CASE CM 273 SUITE OPEN-END ELEMENT WITH 1 ARMREST HIGH SQUARE WITH CASE CM 273

CASE MOD. A

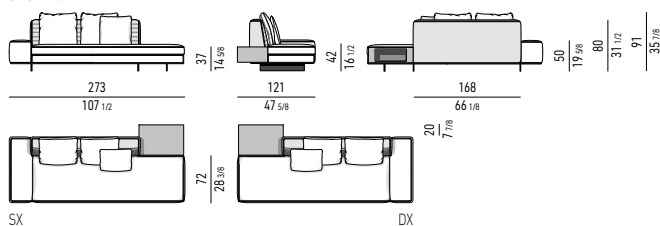

ELEMENTI DAYBED | DAYBED ELEMENTS

SUITE ELEMENTO DAYBED LOW CON CASE CM 221 SUITE DAYBED ELEMENT LOW WITH CASE CM 221

CASE MOD. A

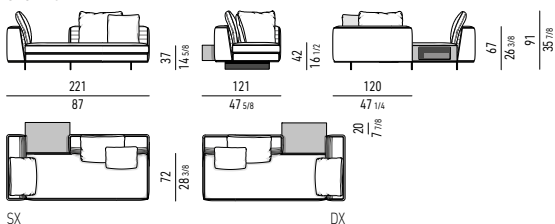

SUITE ELEMENTO DAYBED HIGH CON CASE CM 221 SUITE DAYBED ELEMENT HIGH WITH CASE CM 221

CASE MOD. A

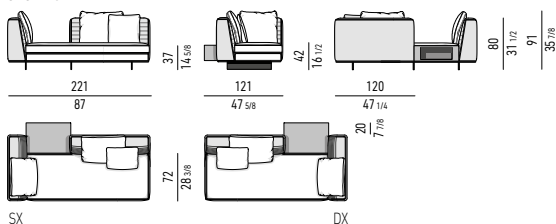

SUITE ELEMENTO DAYBED LOW MIX CON CASE CM 221 SUITE DAYBED ELEMENT LOW MIX WITH CASE CM 221

CASE MOD. A

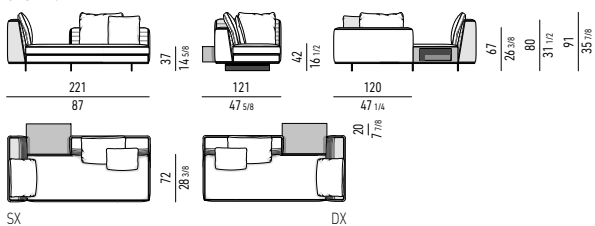

SUITE ELEMENTO DAYBED HIGH MIX CON CASE CM 221 SUITE DAYBED ELEMENT HIGH MIX WITH CASE CM 221

CASE MOD. A

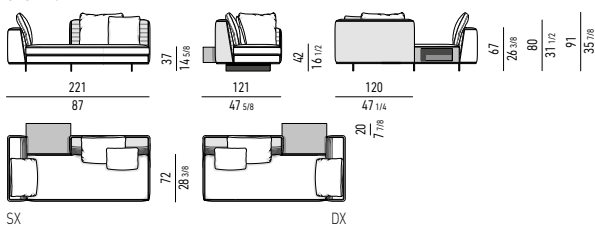

SUITE ELEMENTO DAYBED LOW CON CASE CM 245 SUITE DAYBED ELEMENT LOW WITH CASE CM 245

CASE MOD. A

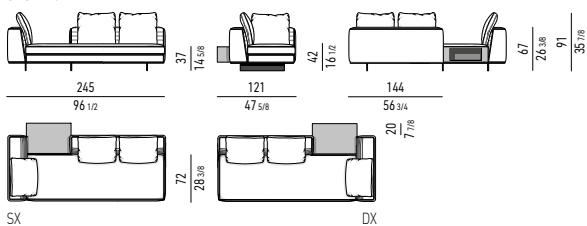

SUITE ELEMENTO DAYBED HIGH CON CASE CM 245 SUITE DAYBED ELEMENT HIGH WITH CASE CM 245

CASE MOD. A

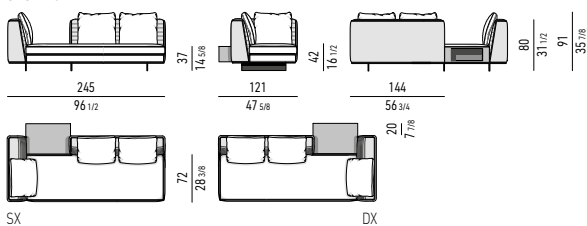

Minotti

SUITE ELEMENTO DAYBED LOW MIX CON CASE CM 245 SUITE DAYBED ELEMENT LOW MIX WITH CASE CM 245

CASE MOD. A

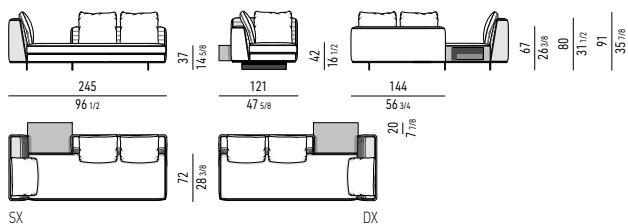

SUITE ELEMENTO DAYBED HIGH MIX CON CASE CM 245 SUITE DAYBED ELEMENT HIGH MIX WITH CASE CM 245

CASE MOD. A

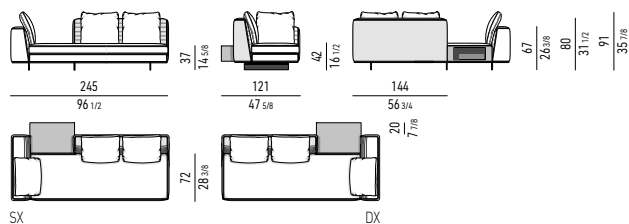

SUITE ELEMENTO DAYBED LOW CON CASE CM 269 SUITE DAYBED ELEMENT LOW WITH CASE CM 269

CASE MOD. A

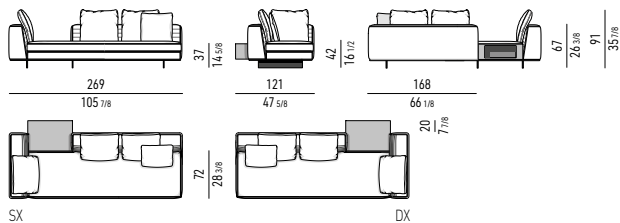

SUITE ELEMENTO DAYBED HIGH CON CASE CM 269 SUITE DAYBED ELEMENT HIGH WITH CASE CM 269

CASE MOD. A

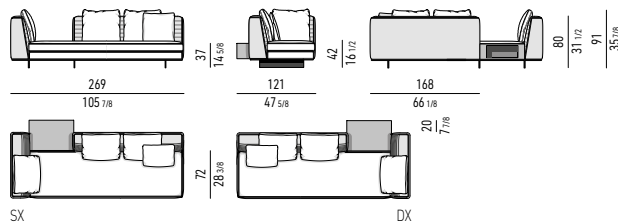

SUITE ELEMENTO DAYBED LOW MIX CON CASE CM 269 SUITE DAYBED ELEMENT LOW MIX WITH CASE CM 269

CASE MOD. A

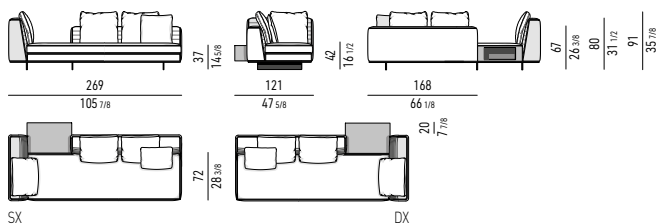

SUITE ELEMENTO DAYBED HIGH MIX CON CASE CM 269 SUITE DAYBED ELEMENT HIGH MIX WITH CASE CM 269

CASE MOD. A

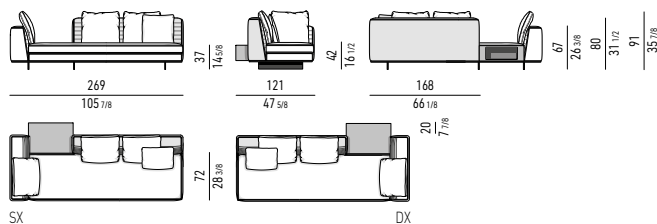

SUITE ELEMENTO DAYBED LOW CON 2 CASE CM 269 SUITE DAYBED ELEMENT LOW WITH 2 CASE CM 269

CASE MOD. A + B

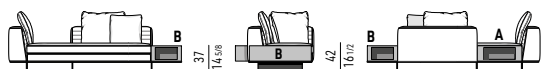

CASE MOD. A + C

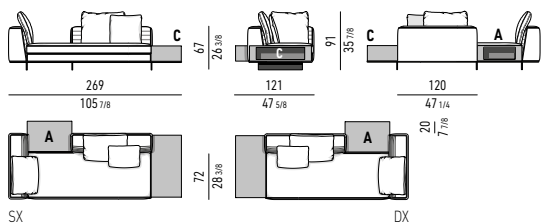

SUITE ELEMENTO DAYBED HIGH CON 2 CASE CM 269 SUITE DAYBED ELEMENT HIGH WITH 2 CASE CM 269

CASE MOD. A + B

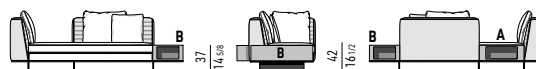

CASE MOD. A + C

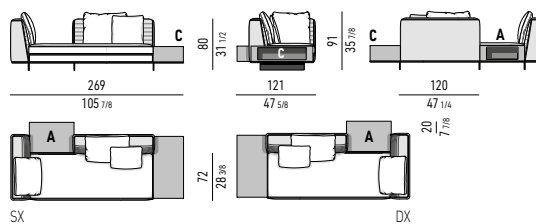

Minotti

SUITE ELEMENTO DAYBED LOW MIX CON 2 CASE CM 269 SUITE DAYBED ELEMENT LOW MIX WITH 2 CASE CM 269

CASE MOD. A + B



CASE MOD. A + C

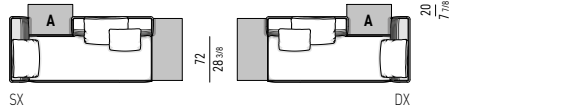
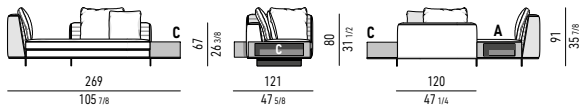

SX

DX

SUITE ELEMENTO DAYBED HIGH MIX CON 2 CASE CM 269 SUITE DAYBED ELEMENT HIGH MIX WITH 2 CASE CM 269

CASE MOD. A + B

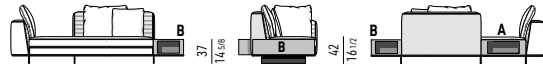

CASE MOD. A + C

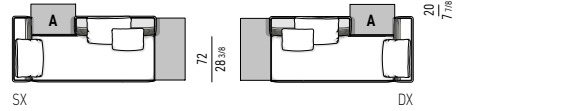
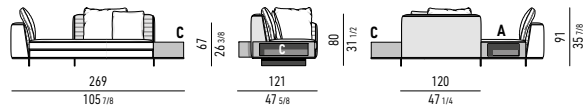

SX

DX

SUITE ELEMENTO DAYBED LOW CON 2 CASE CM 293 SUITE DAYBED ELEMENT LOW WITH 2 CASE CM 293

CASE MOD. A + B

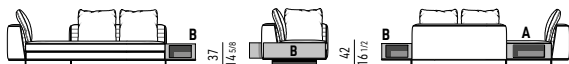

CASE MOD. A + C

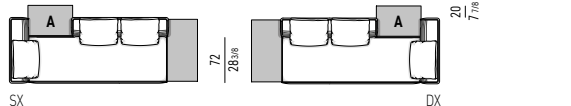
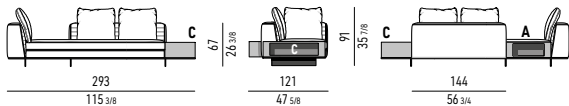

SX

DX

SUITE ELEMENTO DAYBED HIGH CON 2 CASE CM 293 SUITE DAYBED ELEMENT HIGH WITH 2 CASE CM 293

CASE MOD. A + B

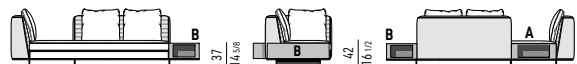

CASE MOD. A + C

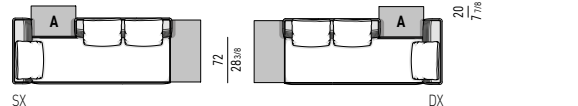
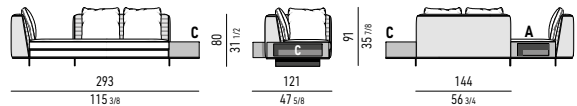

SX

DX

SUITE ELEMENTO DAYBED LOW MIX CON 2 CASE CM 293 SUITE DAYBED ELEMENT LOW MIX WITH 2 CASE CM 293

CASE MOD. A + B

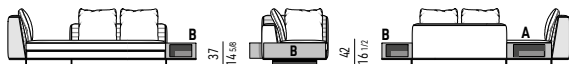

CASE MOD. A + C

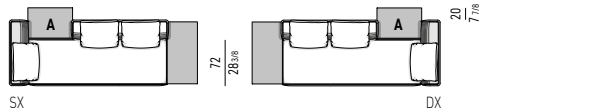
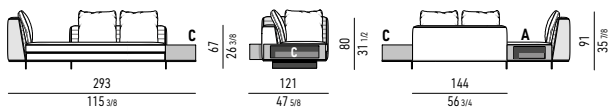

SX

DX

SUITE ELEMENTO DAYBED HIGH MIX CON 2 CASE CM 293 SUITE DAYBED ELEMENT HIGH MIX WITH 2 CASE CM 293

CASE MOD. A + B

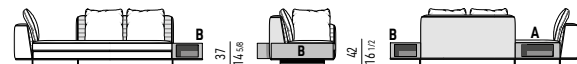

CASE MOD. A + C

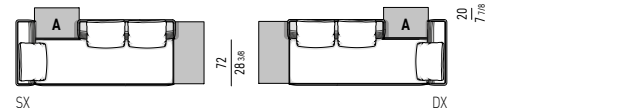
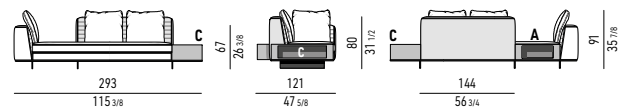

SX

DX

SUITE ELEMENTO DAYBED LOW CON 2 CASE CM 317 SUITE DAYBED ELEMENT LOW WITH 2 CASE CM 317

CASE MOD. A + B

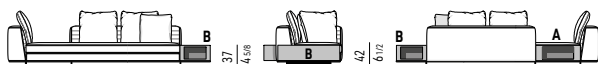

CASE MOD. A + C

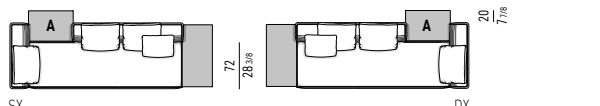
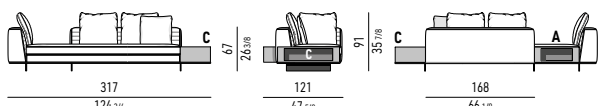

SX

DX

SUITE ELEMENTO DAYBED HIGH CON 2 CASE CM 317 SUITE DAYBED ELEMENT HIGH WITH 2 CASE CM 317

CASE MOD. A + B

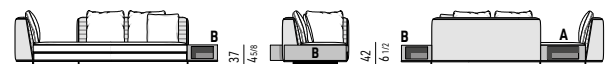

CASE MOD. A + C

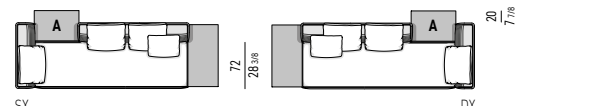
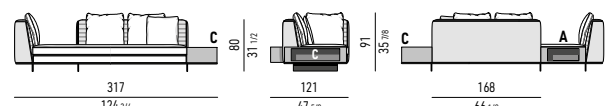

SX

DX

Minotti

SUITE ELEMENTO DAYBED LOW MIX CON 2 CASE CM 317 SUITE DAYBED ELEMENT LOW MIX WITH 2 CASE CM 317

CASE MOD. A + B

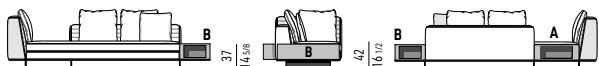

CASE MOD. A + C

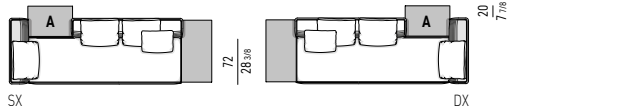
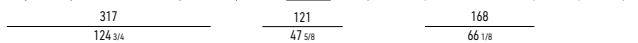

SX

DX

SUITE ELEMENTO DAYBED HIGH MIX CON 2 CASE CM 317 SUITE DAYBED ELEMENT HIGH MIX WITH 2 CASE CM 317

CASE MOD. A + B



CASE MOD. A + C

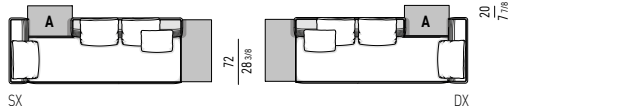
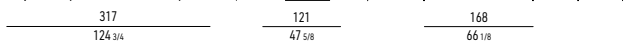

SX

DX

ELEMENTI CENTRALI | CENTRAL ELEMENTS

SUITE ELEMENTO CENTRALE LOW CM 144 SUITE CENTRAL ELEMENT LOW CM 144

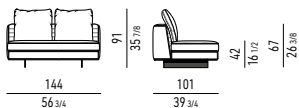

SUITE ELEMENTO CENTRALE HIGH CM 144 SUITE CENTRAL ELEMENT HIGH CM 144

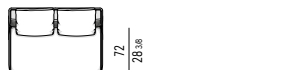
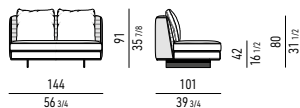

SUITE ELEMENTO CENTRALE LOW CM 168 SUITE CENTRAL ELEMENT LOW CM 168

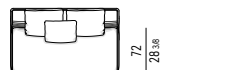
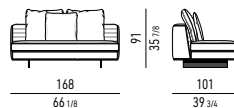

SUITE ELEMENTO CENTRALE HIGH CM 168 SUITE CENTRAL ELEMENT HIGH CM 168

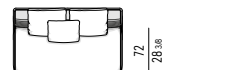
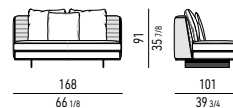

SUITE ELEMENTO CENTRALE LOW CM 192 SUITE CENTRAL ELEMENT LOW CM 192

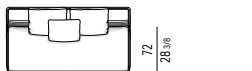
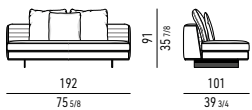

SUITE ELEMENTO CENTRALE HIGH CM 192 SUITE CENTRAL ELEMENT HIGH CM 192

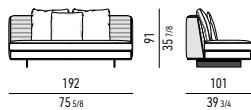

SUITE ELEMENTO CENTRALE LOW CM 216 SUITE CENTRAL ELEMENT LOW CM 216

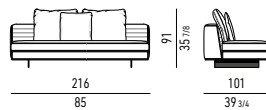

SUITE ELEMENTO CENTRALE HIGH CM 216 SUITE CENTRAL ELEMENT HIGH CM 216

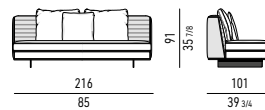

SUITE ELEMENTO CENTRALE LOW CM 240 SUITE CENTRAL ELEMENT LOW CM 240

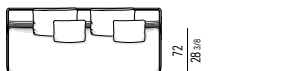
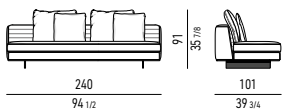

SUITE ELEMENTO CENTRALE HIGH CM 240 SUITE CENTRAL ELEMENT HIGH CM 240

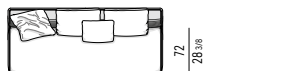
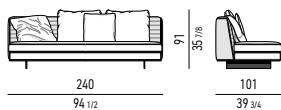

ELEMENTI CENTRALI CON "CASE" | CENTRAL ELEMENTS WITH "CASE"

SUITE ELEMENTO CENTRALE LOW CON CASE CM 192 SUITE CENTRAL ELEMENT LOW WITH CASE CM 192

CASE MOD. B



CASE MOD. C

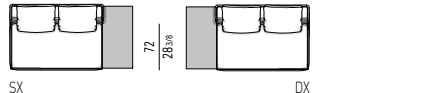
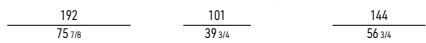

SX

DX

SUITE ELEMENTO CENTRALE HIGH CON CASE CM 192 SUITE CENTRAL ELEMENT HIGH WITH CASE CM 192

CASE MOD. B



CASE MOD. C

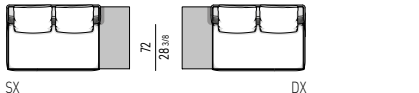
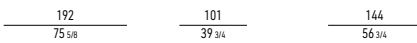

SX

DX

SUITE ELEMENTO CENTRALE LOW CON CASE CM 216
SUITE CENTRAL ELEMENT LOW WITH CASE CM 216

CASE MOD. B



CASE MOD. C

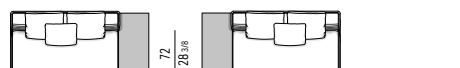
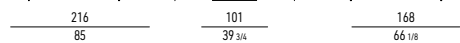

SX DX

SUITE ELEMENTO CENTRALE HIGH CON CASE CM 216
SUITE CENTRAL ELEMENT HIGH WITH CASE CM 216

CASE MOD. B



CASE MOD. C

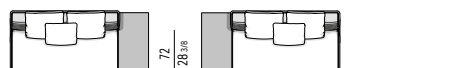
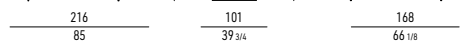

SX DX

SUITE ELEMENTO CENTRALE LOW CON CASE CM 240
SUITE CENTRAL ELEMENT LOW WITH CASE CM 240

CASE MOD. B



CASE MOD. C

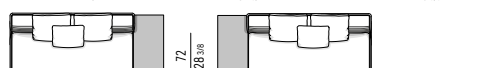
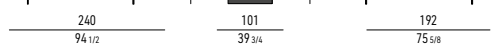

SX DX

SUITE ELEMENTO CENTRALE HIGH CON CASE CM 240
SUITE CENTRAL ELEMENT HIGH WITH CASE CM 240

CASE MOD. B



CASE MOD. C

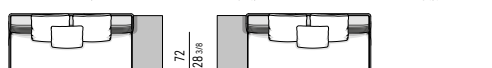
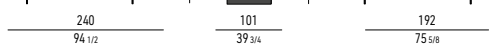

SX DX

ELEMENTI PENISOLA CON "CASE" | OPEN-END ELEMENTS WITH "CASE"

SUITE ELEMENTO PENISOLA LOW CON CASE CM 192
SUITE OPEN-END ELEMENT LOW WITH CASE CM 192

CASE MOD. A

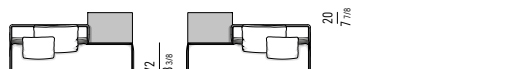
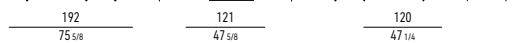

SX DX

SUITE ELEMENTO PENISOLA HIGH CON CASE CM 192
SUITE OPEN-END ELEMENT HIGH WITH CASE CM 192

CASE MOD. A

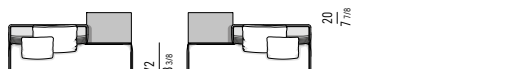
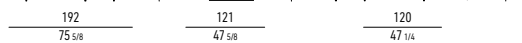

SX DX

SUITE ELEMENTO PENISOLA LOW CON CASE CM 216
SUITE OPEN-END ELEMENT LOW WITH CASE CM 216

CASE MOD. A

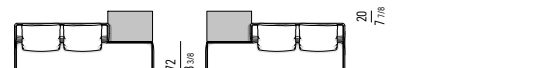
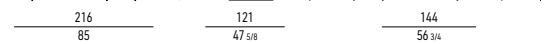

SX DX

SUITE ELEMENTO PENISOLA HIGH CON CASE CM 216
SUITE OPEN-END ELEMENT HIGH WITH CASE CM 216

CASE MOD. A

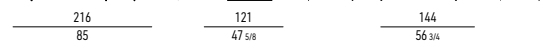

SX DX

SUITE ELEMENTO PENISOLA LOW CON CASE CM 240
SUITE OPEN-END ELEMENT LOW WITH CASE CM 240

CASE MOD. A

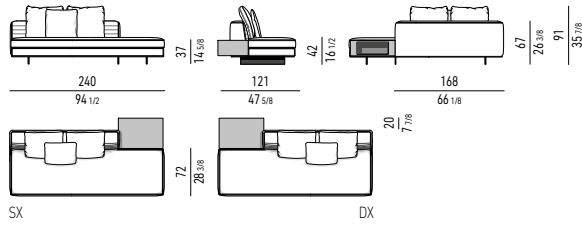

SUITE ELEMENTO PENISOLA HIGH CON CASE CM 240
SUITE OPEN-END ELEMENT HIGH WITH CASE CM 240

CASE MOD. A

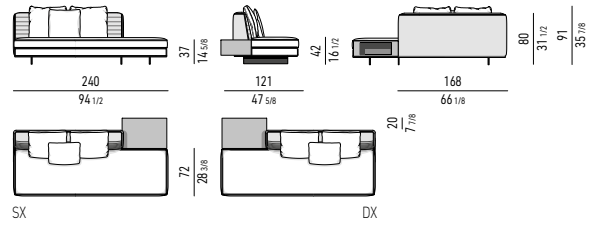

SUITE ELEMENTO PENISOLA LOW CON 2 CASE CM 240
SUITE OPEN-END ELEMENT LOW WITH 2 CASE CM 240

CASE MOD. A + B

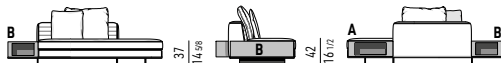

CASE MOD. A + C

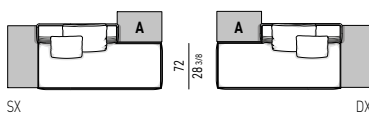
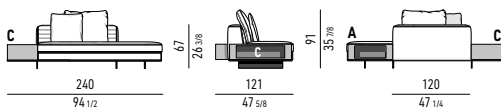

SUITE ELEMENTO PENISOLA HIGH CON 2 CASE CM 240
SUITE OPEN-END ELEMENT HIGH WITH 2 CASE CM 240

CASE MOD. A + B

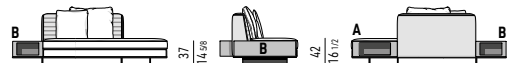

CASE MOD. A + C

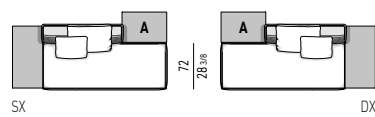
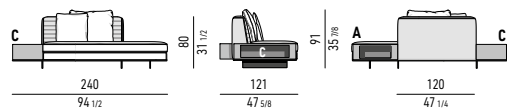

SUITE ELEMENTO PENISOLA LOW CON 2 CASE CM 264
SUITE OPEN-END ELEMENT LOW WITH 2 CASE CM 264

CASE MOD. A + B

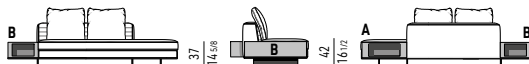

CASE MOD. A + C

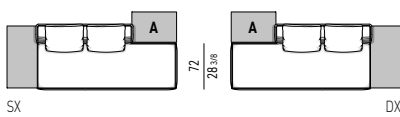
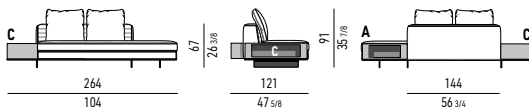

SUITE ELEMENTO PENISOLA HIGH CON 2 CASE CM 264
SUITE OPEN-END ELEMENT HIGH WITH 2 CASE CM 264

CASE MOD. A + B

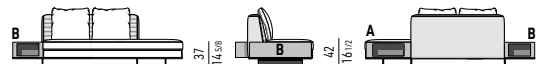

CASE MOD. A + C

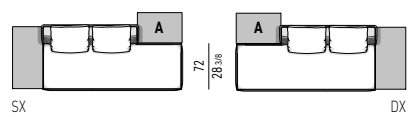
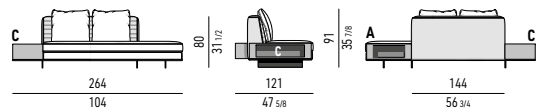

SUITE ELEMENTO PENISOLA LOW CON 2 CASE CM 288
SUITE OPEN-END ELEMENT LOW WITH 2 CASE CM 288

CASE MOD. A + B

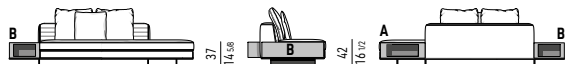

CASE MOD. A + C

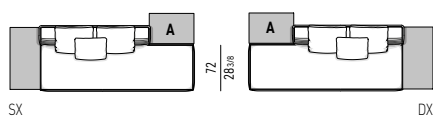
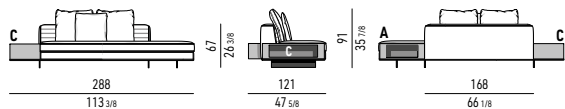

SUITE ELEMENTO PENISOLA HIGH CON 2 CASE CM 288
SUITE OPEN-END ELEMENT HIGH WITH 2 CASE CM 288

CASE MOD. A + B

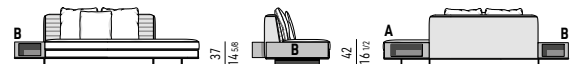

CASE MOD. A + C

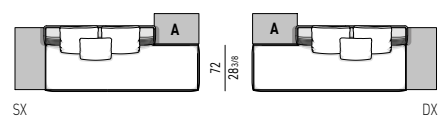
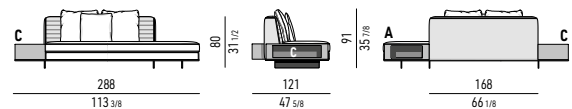

Minotti

COUCH

SUITE COUCH LOW CM 120X173
SUITE COUCH LOW CM 120X173

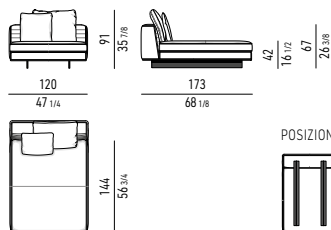

POUF | OTTOMANS

SUITE POUF CM 109X109
SUITE OTTOMAN CM 109X109

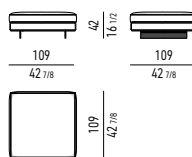

SUITE POUF CM 101X101
SUITE OTTOMAN CM 101X101

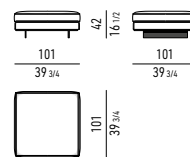

CHAISE-LONGUES

SUITE CHAISE-LONGUE LOW CM 149X173
SUITE CHAISE-LONGUE LOW CM 149X173

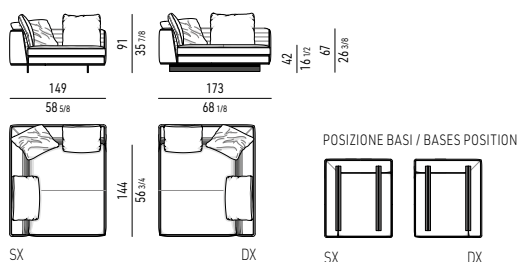

SUITE CHAISE-LONGUE LOW CM 173X173
SUITE CHAISE-LONGUE LOW CM 173X173

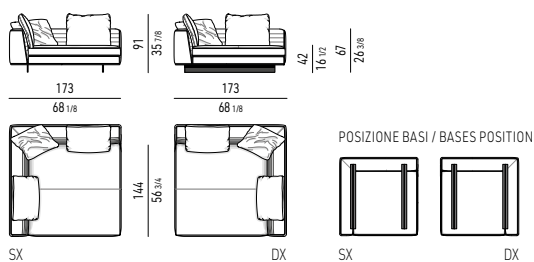

SUITE CHAISE-LONGUE LOW CON CASE CM 193X173
SUITE CHAISE-LONGUE LOW WITH CASE CM 193X173

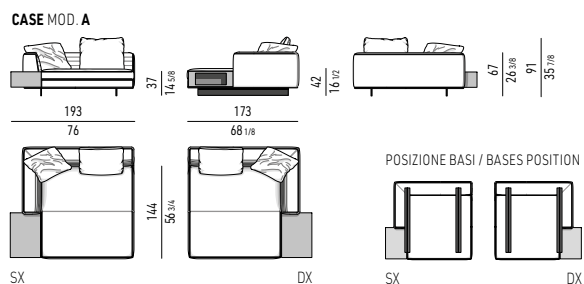

SUITE CHAISE-LONGUE LOW CON CASE CM 197X193
SUITE CHAISE-LONGUE LOW WITH CASE CM 197X193

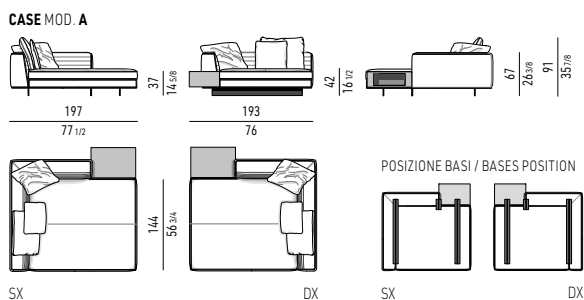

SUITE CHAISE-LONGUE OPEN LOW CON CASE CM 193X197
SUITE OPEN CHAISE-LONGUE LOW WITH CASE CM 193X197

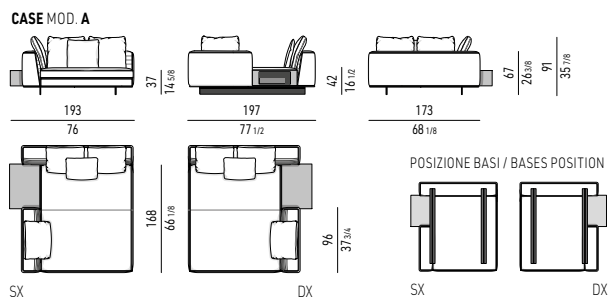

SUITE CHAISE-LONGUE OPEN LOW CON CASE CM 197X193
SUITE OPEN CHAISE-LONGUE LOW WITH CASE CM 197X193

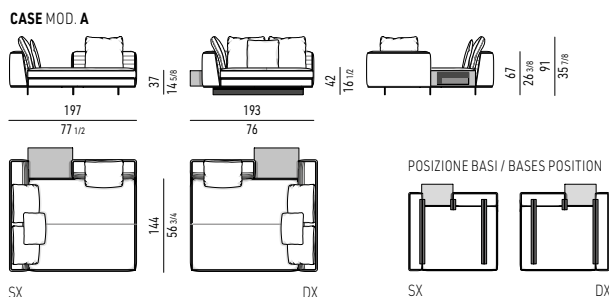

ROGER SUITE BACK TO BACK 72

PROFONDITÀ DI SEDUTA CM 72 | SEAT DEPTH CM 72

SUITE BACK TO BACK ELEMENTO LOW CM 168X180
 SUITE BACK TO BACK ELEMENT LOW CM 168X180

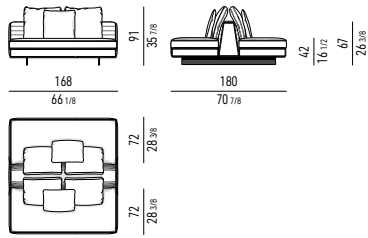

SUITE BACK TO BACK ELEMENTO HIGH CM 168X180
 SUITE BACK TO BACK ELEMENT HIGH CM 168X180

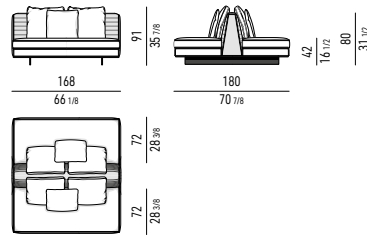

SUITE BACK TO BACK ELEMENTO LOW CM 192X180
 SUITE BACK TO BACK ELEMENT LOW CM 192X180

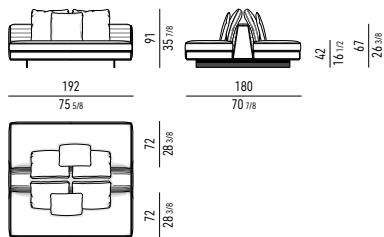

SUITE BACK TO BACK ELEMENTO HIGH CM 192X180
 SUITE BACK TO BACK ELEMENT HIGH CM 192X180

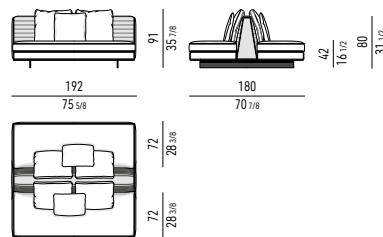

SUITE BACK TO BACK ELEMENTO LOW CM 216X180
 SUITE BACK TO BACK ELEMENT LOW CM 216X180

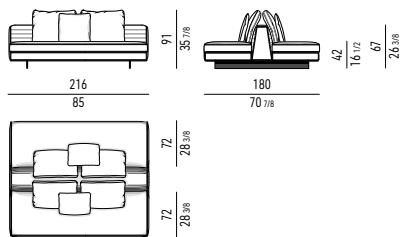

SUITE BACK TO BACK ELEMENTO HIGH CM 216X180
 SUITE BACK TO BACK ELEMENT HIGH CM 216X180

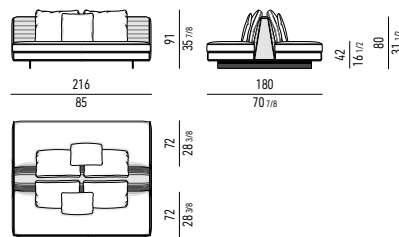

ELEMENTI "CASE" | "CASE" ELEMENTS

CASE MOD. H	CASE MOD. I
<p>Dimensioni dimensions: CM 48X106 H24</p> <p>Spazio utile storage space: CM 33,5X46,5 H18</p>	<p>Dimensioni dimensions: CM 48X106 H24</p> <p>Spazio utile storage space: CM 83X32 H18</p>

SUITE BACK TO BACK ELEMENTO LOW CON CASE CM 192X180
SUITE BACK TO BACK ELEMENT LOW WITH CASE CM 192X180

CASE MOD. H



CASE MOD. I

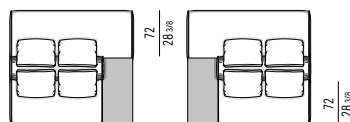
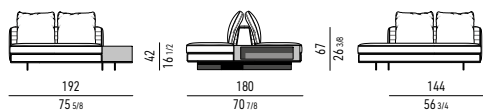

SX DX

SUITE BACK TO BACK ELEMENTO HIGH CON CASE CM 192X180
SUITE BACK TO BACK ELEMENT HIGH WITH CASE CM 192X180

CASE MOD. H

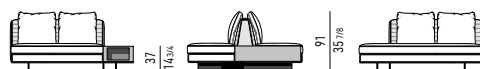

CASE MOD. I

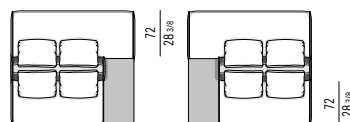
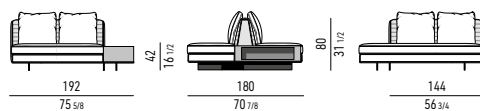

SX DX

SUITE BACK TO BACK ELEMENTO LOW CON CASE CM 216X180
SUITE BACK TO BACK ELEMENT LOW WITH CASE CM 216X180

CASE MOD. H



CASE MOD. I

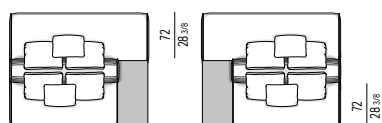
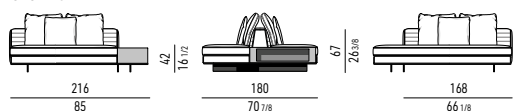

SX DX

SUITE BACK TO BACK ELEMENTO HIGH CON CASE CM 216X180
SUITE BACK TO BACK ELEMENT HIGH WITH CASE CM 216X180

CASE MOD. H

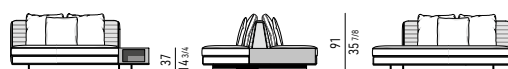

CASE MOD. I

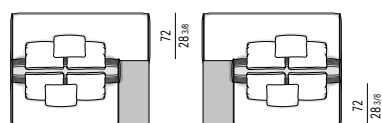
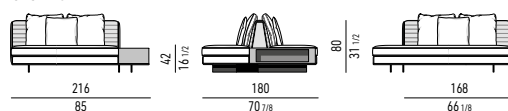

SX DX

AVVERTENZA | WARNING

PROFONDITÀ DI SEDUTA DEGLI ELEMENTI **SUITE BACK TO BACK 72**
 SEAT DEPTH OF THE **SUITE BACK TO BACK 72** ELEMENTS

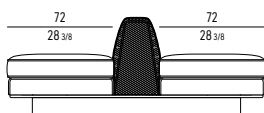

PROFONDITÀ DI SEDUTA DEGLI ELEMENTI **SUITE BACK TO BACK 72**
 SEAT DEPTH OF THE **SUITE BACK TO BACK 72** ELEMENTS

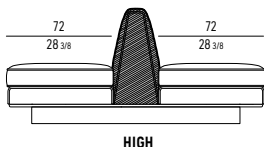

ACCOSTAMENTO DI ELEMENTI **BACK TO BACK LOW** CON ELEMENTI SUITE O SPRING **LOW**
 JUXTAPOSITION BETWEEN **BACK TO BACK LOW** ELEMENTS AND SUITE OR SPRING **LOW** ELEMENTS

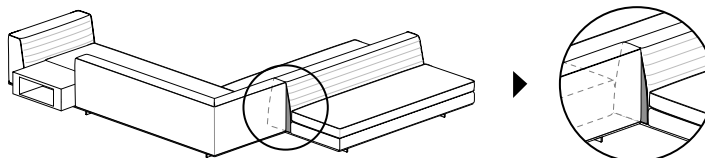

ACCOSTAMENTO DI ELEMENTI **BACK TO BACK HIGH** CON ELEMENTI SUITE O SPRING **HIGH** - **SCONSIGLIATO!**
 JUXTAPOSITION BETWEEN **BACK TO BACK HIGH** ELEMENTS AND SUITE OR SPRING **HIGH** ELEMENTS - **NOT RECOMMENDED!**

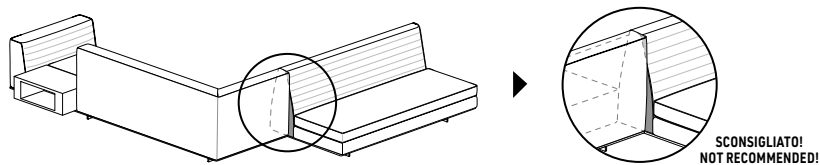

Minotti

ROGER BACK TO BACK MIX

PROFONDITÀ DI SEDUTA CM 72-65 | SEAT DEPTH CM 72-65

BACK TO BACK MIX ELEMENTO LOW CM 168X173
BACK TO BACK MIX ELEMENT LOW CM 168X173

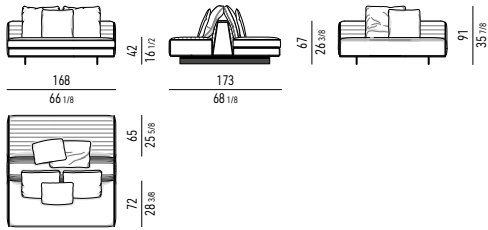

BACK TO BACK MIX ELEMENTO HIGH CM 168X173
BACK TO BACK MIX ELEMENT HIGH CM 168X173

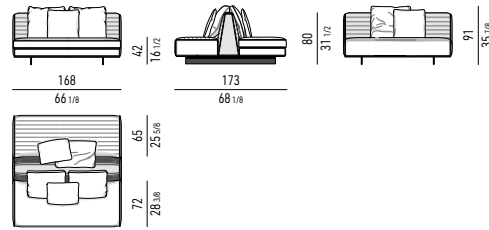

BACK TO BACK MIX ELEMENTO LOW CM 192X173
BACK TO BACK MIX ELEMENT LOW CM 192X173

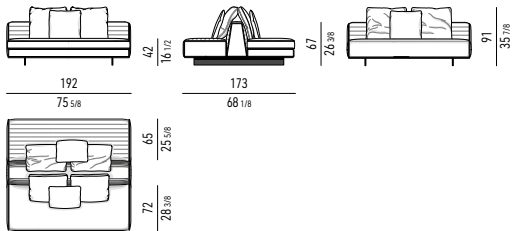

BACK TO BACK MIX ELEMENTO HIGH CM 192X173
BACK TO BACK MIX ELEMENT HIGH CM 192X173

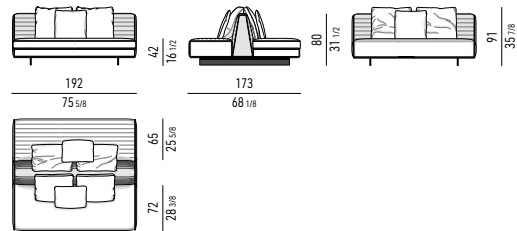

BACK TO BACK MIX ELEMENTO LOW CM 216X173
BACK TO BACK MIX ELEMENT LOW CM 216X173

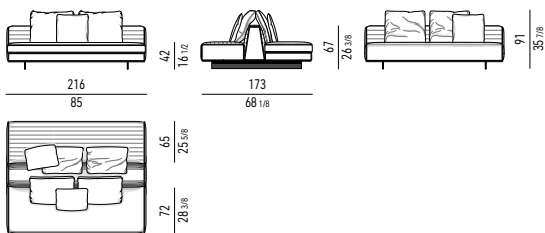

BACK TO BACK MIX ELEMENTO LOW CM 216X173
BACK TO BACK MIX ELEMENT LOW CM 216X173

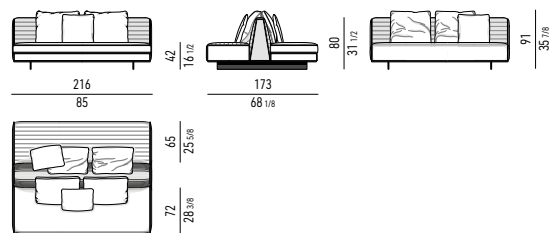

AVVERTENZA | WARNING

PROFONDITÀ DI SEDUTA DEGLI ELEMENTI **BACK TO BACK MIX**
 SEAT DEPTH OF THE **BACK TO BACK MIX** ELEMENTS

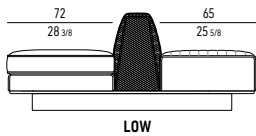

PROFONDITÀ DI SEDUTA DEGLI ELEMENTI **BACK TO BACK MIX**
 SEAT DEPTH OF THE **BACK TO BACK MIX** ELEMENTS

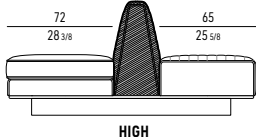

ACCOSTAMENTO DI ELEMENTI **BACK TO BACK LOW** CON ELEMENTI SUITE O SPRING **LOW**
 JUXTAPOSITION BETWEEN **BACK TO BACK LOW** ELEMENTS AND SUITE OR SPRING **LOW** ELEMENTS

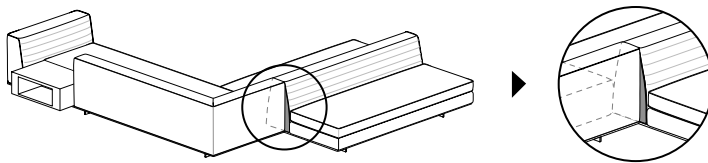

ACCOSTAMENTO DI ELEMENTI **BACK TO BACK HIGH** CON ELEMENTI SUITE O SPRING **HIGH** - **SCONSIGLIATO!**
 JUXTAPOSITION BETWEEN **BACK TO BACK HIGH** ELEMENTS AND SUITE OR SPRING **HIGH** ELEMENTS - **NOT RECOMMENDED!**

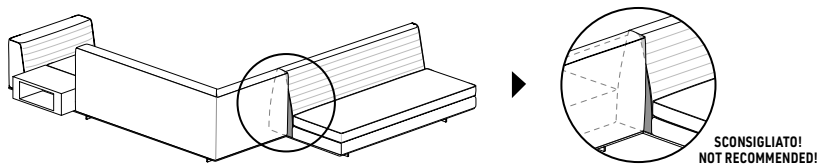

ELEMENTI "CASE" | "CASE" ELEMENTS

CASE MOD. C

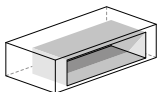

Dimensioni | dimensions:
 CM 48X98 H24
Spazio utile | storage space:
 CM 75X32 H18

CASE MOD. F

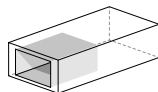

Dimensioni | dimensions:
 CM 48X98 H24
Spazio utile | storage space:
 CM 33,5X46,5 H18

CASE MOD. H

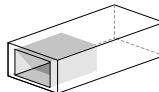

Dimensioni | dimensions:
 CM 48X106 H24
Spazio utile | storage space:
 CM 33,5X46,5 H18

CASE MOD. I

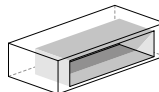

Dimensioni | dimensions:
 CM 48X106 H24
Spazio utile | storage space:
 CM 83X32 H18

Minotti

BACK TO BACK MIX ELEMENTO LOW CON CASE SUITE CM 192X173 BACK TO BACK MIX ELEMENT LOW WITH CASE SUITE CM 192X173

CASE MOD. H

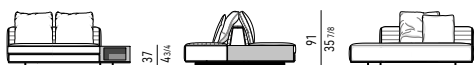

CASE MOD. I

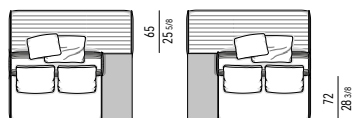
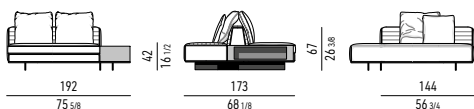

SX

DX

BACK TO BACK MIX ELEMENTO HIGH CON CASE SUITE CM 192X173 BACK TO BACK MIX ELEMENT HIGH WITH CASE SUITE CM 192X173

CASE MOD. H



CASE MOD. I

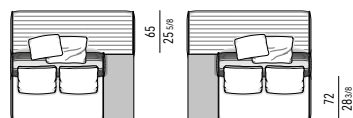
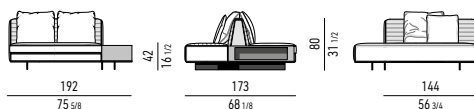

SX

DX

BACK TO BACK MIX ELEMENTO LOW CON CASE SPRING CM 192X173 BACK TO BACK MIX ELEMENT LOW WITH CASE SPRING CM 192X173

CASE MOD. F



CASE MOD. C

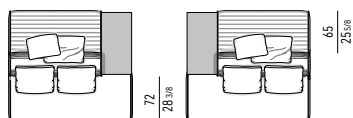
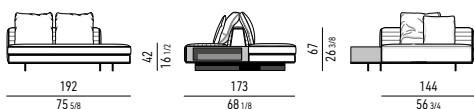

SX

DX

BACK TO BACK MIX ELEMENTO HIGH CON CASE SPRING CM 192X173 BACK TO BACK MIX ELEMENT HIGH WITH CASE SPRING CM 192X173

CASE MOD. F



CASE MOD. C

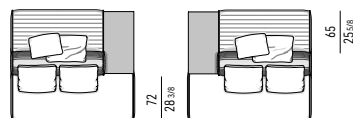
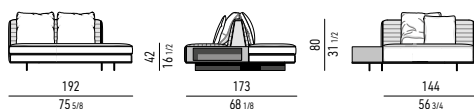

SX

DX

BACK TO BACK MIX ELEMENTO LOW CON CASE SUITE CM 216X173 BACK TO BACK MIX ELEMENT LOW WITH CASE SUITE CM 216X173

CASE MOD. H



CASE MOD. I

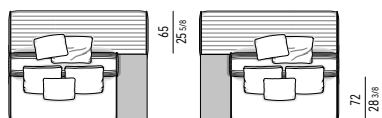
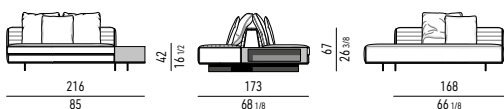

SX

DX

BACK TO BACK MIX ELEMENTO HIGH CON CASE SUITE CM 216X173 BACK TO BACK MIX ELEMENT HIGH WITH CASE SUITE CM 216X173

CASE MOD. H



CASE MOD. I

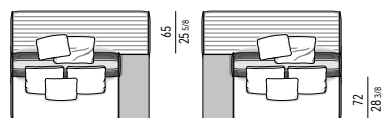
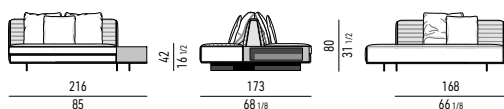

SX

DX

BACK TO BACK MIX ELEMENTO LOW CON CASE SPRING CM 216X173 BACK TO BACK MIX ELEMENT LOW WITH CASE SPRING CM 216X173

CASE MOD. F



CASE MOD. C

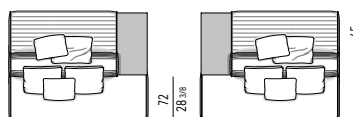
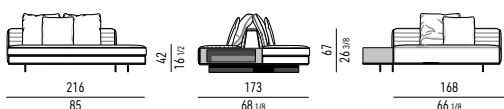

SX

DX

BACK TO BACK MIX ELEMENTO HIGH CON CASE SPRING CM 216X173 BACK TO BACK MIX ELEMENT HIGH WITH CASE SPRING CM 216X173

CASE MOD. F



CASE MOD. C

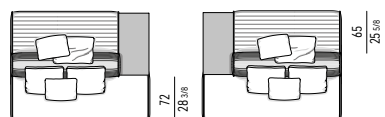
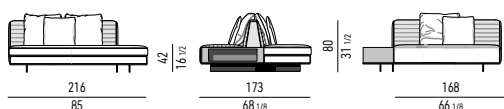

SX

DX

BRACCIOLO AMOVIBILE REMOVABLE ARMREST

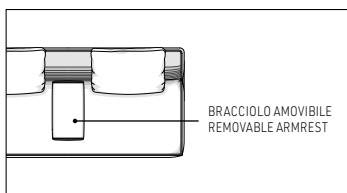
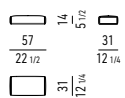

POGGIATESTA | HEADREST

POGGIATESTA OPTIONAL ROGER CM 72 ROGER OPTIONAL HEADREST CM 72

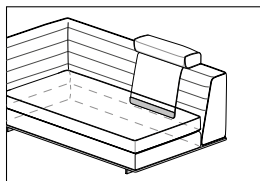
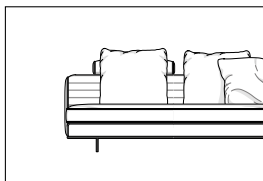
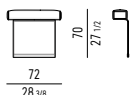

DA UTILIZZARE ESCLUSIVAMENTE CON ELEMENTI "LOW"
TO USE ONLY WITH "LOW" ELEMENTS

CUSCINI SCHIENALE OPTIONAL OPTIONAL BACKREST CUSHIONS



CUSCINO OPTIONAL OPTIONAL CUSHION

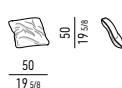

MIRAGE MINOTTI STUDIO DESIGN

CUSCINI OPTIONAL "MIRAGE" "MIRAGE" OPTIONAL CUSHIONS



VISTA FRONTALE E POSTERIORE DEI CUSCINI "MIRAGE" FRONT AND BACK VIEW OF THE "MIRAGE" CUSHIONS

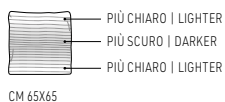

CM 65X65

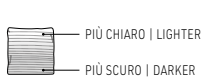

CM 50x50

DOUBLE MINOTTI STUDIO DESIGN

CUSCINI OPTIONAL "DOUBLE" "DOUBLE" OPTIONAL CUSHIONS

FRONTE | FRONT

RETRO | BACK



FRONTE | FRONT

RETRO | BACK



VISTA FRONTALE DEI CUSCINI "DOUBLE" CONFEZIONATI CON TESSUTO "MIRAGE" FRONT VIEW OF THE "DOUBLE" CUSHIONS UPHOLSTERED IN "MIRAGE" FABRIC

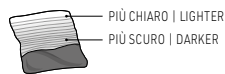

CM 65X65



CM 50x50

Minotti

ROGER SPRING

DIVANI | SOFAS

SPRING DIVANO LOW CM 250 SPRING SOFA LOW CM 250

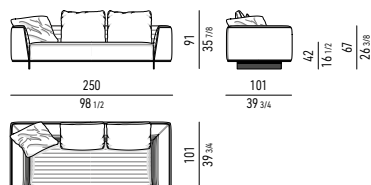

SPRING DIVANO HIGH SQUARE CM 258 SPRING SOFA HIGH SQUARE CM 258

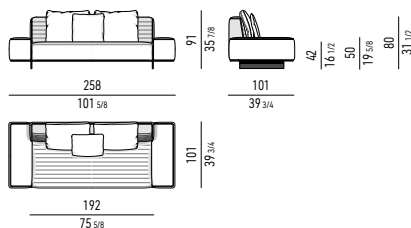

SPRING DIVANO LOW CM 274 SPRING SOFA LOW CM 274

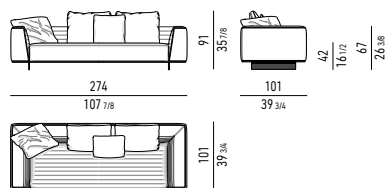

SPRING DIVANO HIGH SQUARE CM 282 SPRING SOFA HIGH SQUARE CM 282

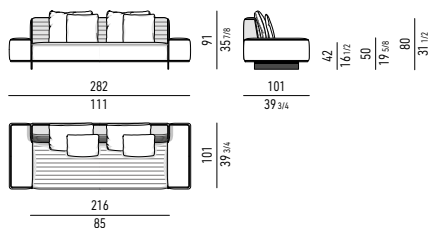

SPRING DIVANO LOW CM 298 SPRING SOFA LOW CM 298

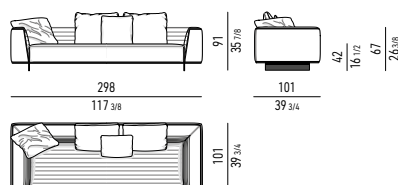

SPRING DIVANO HIGH SQUARE CM 306 SPRING SOFA HIGH SQUARE CM 306

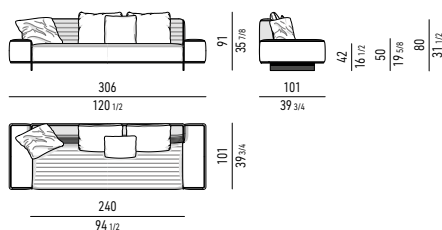

SPRING DIVANO HIGH SQUARE MIX CM 278 SPRING SOFA HIGH SQUARE MIX CM 278

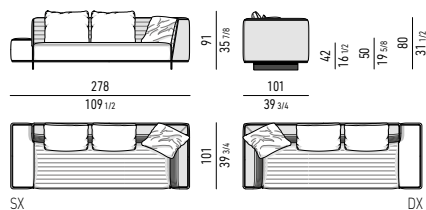

SPRING DIVANO HIGH SQUARE MIX CM 302 SPRING SOFA HIGH SQUARE MIX CM 302

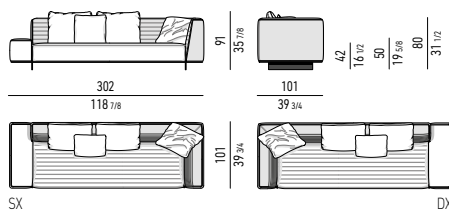

ELEMENTI "CASE" | "CASE" ELEMENTS

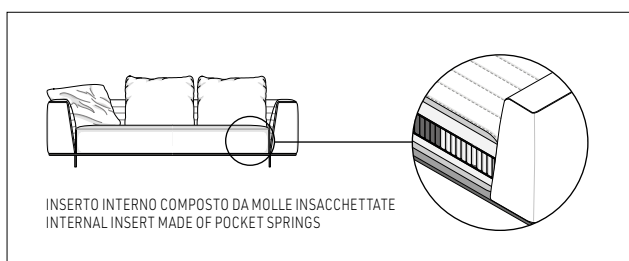
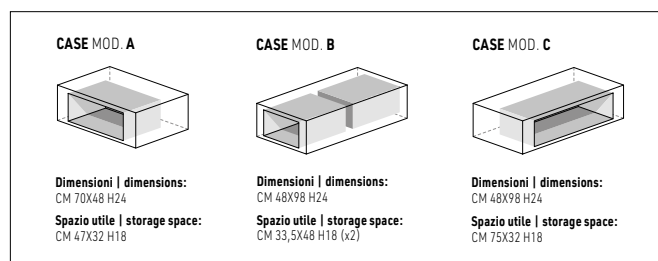

Minotti

DIVANI-DAYBED | DAYBED-SOFAS

SPRING DIVANO-DAYBED LOW CON CASE CM 274 SPRING DAYBED-SOFA LOW WITH CASE CM 274

CASE MOD. A

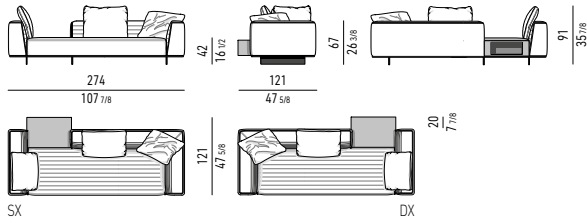

SPRING DIVANO-DAYBED LOW MIX CON CASE CM 274 SPRING DAYBED-SOFA LOW MIX WITH CASE CM 274

CASE MOD. A

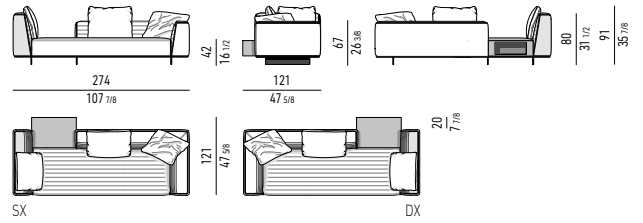

SPRING DIVANO-DAYBED HIGH MIX CON CASE CM 274 SPRING DAYBED-SOFA HIGH MIX WITH CASE CM 274

CASE MOD. A

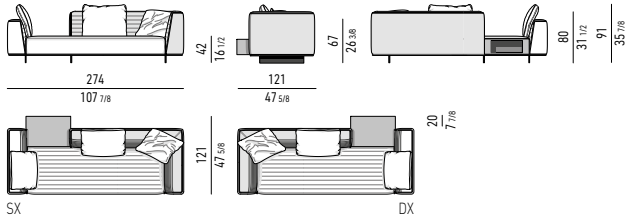

SPRING DIVANO-DAYBED HIGH SQUARE CON CASE CM 278 SPRING DAYBED-SOFA HIGH SQUARE WITH CASE CM 278

CASE MOD. A

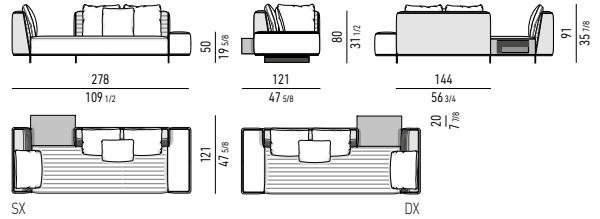

SPRING DIVANO-DAYBED HIGH SQUARE MIX CON CASE CM 278 SPRING DAYBED-SOFA HIGH SQUARE MIX WITH CASE CM 278

CASE MOD. A

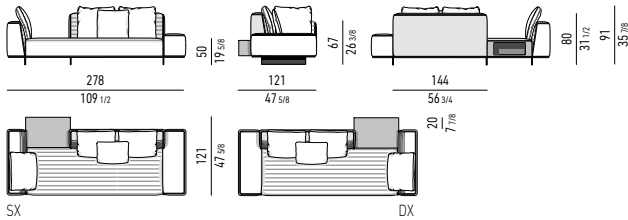

SPRING DIVANO-DAYBED LOW CON CASE CM 298 SPRING DAYBED-SOFA LOW WITH CASE CM 298

CASE MOD. A

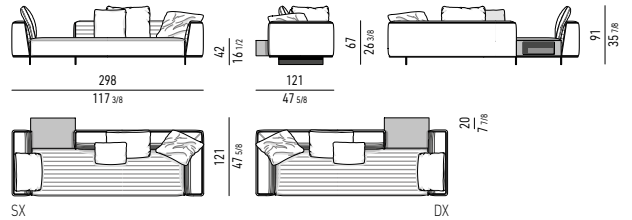

SPRING DIVANO-DAYBED LOW MIX CON CASE CM 298 SPRING DAYBED-SOFA LOW MIX WITH CASE CM 298

CASE MOD. A

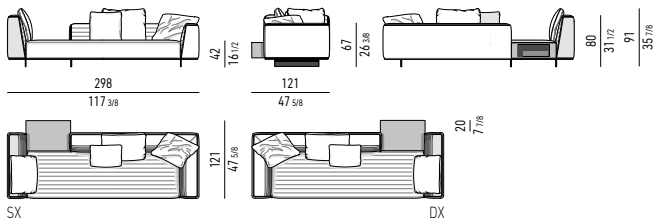

SPRING DIVANO-DAYBED HIGH MIX CON CASE CM 298 SPRING DAYBED-SOFA HIGH MIX WITH CASE CM 298

CASE MOD. A

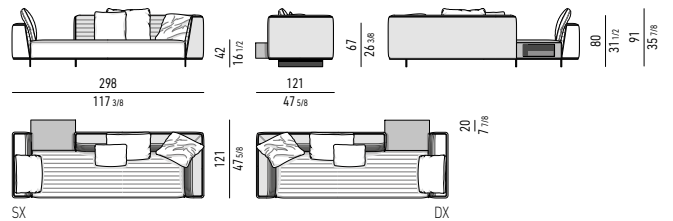

SPRING DIVANO-DAYBED HIGH SQUARE CON CASE CM 302 SPRING DAYBED-SOFA HIGH SQUARE WITH CASE CM 302

CASE MOD. A

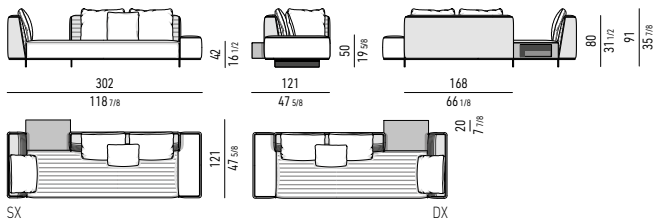

SPRING DIVANO-DAYBED HIGH SQUARE MIX CON CASE CM 302 SPRING DAYBED-SOFA HIGH SQUARE MIX WITH CASE CM 302

CASE MOD. A

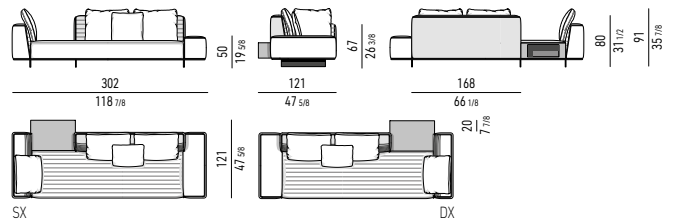

ELEMENTI TERMINALI CON "CASE" | ELEMENTS WITH 1 ARMREST WITH "CASE"

SPRING ELEMENTO TERMINALE LOW CON CASE CM 221
SPRING ELEMENT WITH 1 ARMREST LOW WITH CASE CM 221

CASE MOD. B



CASE MOD. C

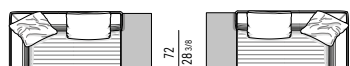

SX

DX

SPRING ELEMENTO TERMINALE HIGH CON CASE CM 221
SPRING ELEMENT WITH 1 ARMREST HIGH WITH CASE CM 221

CASE MOD. B



CASE MOD. C

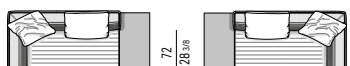

SX

DX

SPRING ELEMENTO TERMINALE HIGH SQUARE CON CASE CM 225
SPRING ELEMENT WITH 1 ARMREST HIGH SQUARE WITH CASE CM 225

CASE MOD. B



CASE MOD. C

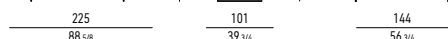

SX

DX

SPRING ELEMENTO TERMINALE LOW CON CASE CM 245
SPRING ELEMENT WITH 1 ARMREST LOW WITH CASE CM 245

CASE MOD. B



CASE MOD. C



SX

DX

SPRING ELEMENTO TERMINALE HIGH CON CASE CM 245
SPRING ELEMENT WITH 1 ARMREST HIGH WITH CASE CM 245

CASE MOD. B



CASE MOD. C

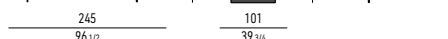

SX

DX

SPRING ELEMENTO TERMINALE HIGH SQUARE CON CASE CM 249
SPRING ELEMENT WITH 1 ARMREST HIGH SQUARE WITH CASE CM 249

CASE MOD. B



CASE MOD. C

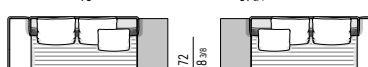
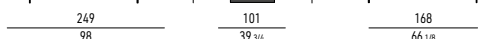

SX

DX

SPRING ELEMENTO TERMINALE LOW CON CASE CM 269
SPRING ELEMENT WITH 1 ARMREST LOW WITH CASE CM 269

CASE MOD. B



CASE MOD. C

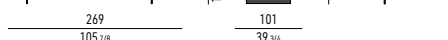

SX

DX

SPRING ELEMENTO TERMINALE HIGH CON CASE CM 269
SPRING ELEMENT WITH 1 ARMREST HIGH WITH CASE CM 269

CASE MOD. B



CASE MOD. C

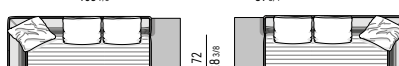
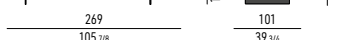

SX

DX

Minotti

SPRING ELEMENTO TERMINALE HIGH SQUARE CON CASE CM 273 SPRING ELEMENT WITH 1 ARMREST HIGH SQUARE WITH CASE CM 273

CASE MOD. B



CASE MOD. C

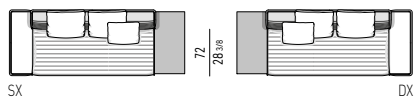
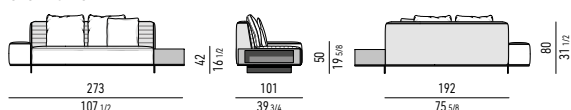

SX DX

ELEMENTI TERMINALI PENISOLA | OPEN-END ELEMENTS WITH 1 ARMREST

SPRING ELEMENTO TERMINALE PENISOLA LOW CON CASE CM 221 SPRING OPEN-END ELEMENT WITH 1 ARMREST LOW WITH CASE CM 221

CASE MOD. A

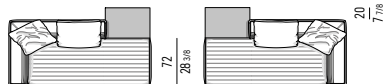
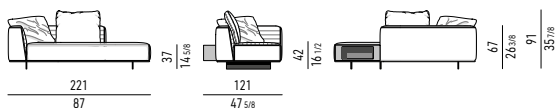

SX DX

SPRING ELEMENTO TERMINALE PENISOLA HIGH CON CASE CM 221 SPRING OPEN-END ELEMENT WITH 1 ARMREST HIGH WITH CASE CM 221

CASE MOD. A

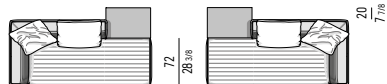
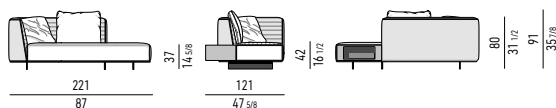

SX DX

SPRING ELEMENTO TERMINALE PENISOLA HIGH SQUARE CON CASE CM 225 SPRING OPEN-END ELEMENT WITH 1 ARMREST HIGH SQUARE WITH CASE CM 225

CASE MOD. A

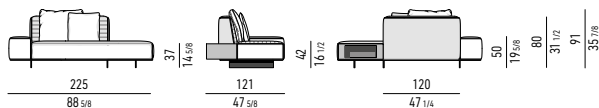

SX DX

SPRING ELEMENTO TERMINALE PENISOLA LOW CON CASE CM 245 SPRING OPEN-END ELEMENT WITH 1 ARMREST LOW WITH CASE CM 245

CASE MOD. A

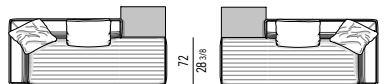
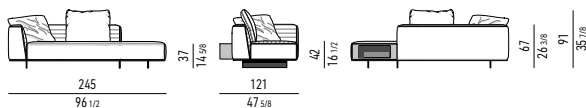

SX DX

SPRING ELEMENTO TERMINALE PENISOLA HIGH CON CASE CM 245 SPRING OPEN-END ELEMENT WITH 1 ARMREST HIGH WITH CASE CM 245

CASE MOD. A

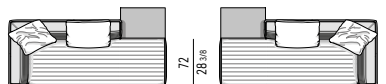
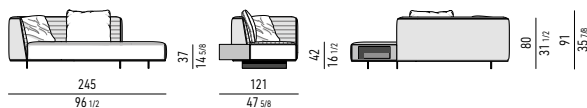

SX DX

SPRING ELEMENTO TERMINALE PENISOLA HIGH SQUARE CON CASE CM 249 SPRING OPEN-END ELEMENT WITH 1 ARMREST HIGH SQUARE WITH CASE CM 249

CASE MOD. A

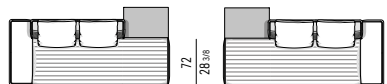
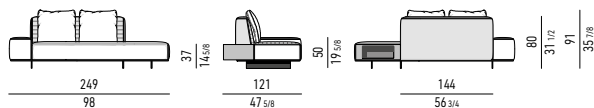

SX DX

SPRING ELEMENTO TERMINALE PENISOLA LOW CON CASE CM 269 SPRING OPEN-END ELEMENT WITH 1 ARMREST LOW WITH CASE CM 269

CASE MOD. A

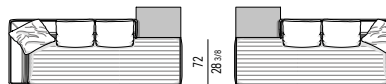
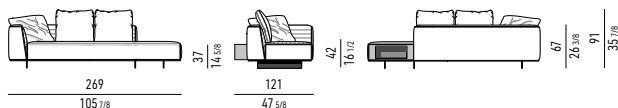

SX DX

SPRING ELEMENTO TERMINALE PENISOLA HIGH CON CASE CM 269 SPRING OPEN-END ELEMENT WITH 1 ARMREST HIGH WITH CASE CM 269

CASE MOD. A

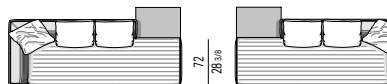
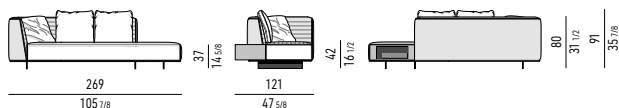

SX DX

Minotti

SPRING ELEMENTO TERMINALE PENISOLA HIGH SQUARE CON CASE CM 273
SPRING OPEN-END ELEMENT WITH 1 ARMREST HIGH SQUARE WITH CASE CM 273

CASE MOD. A

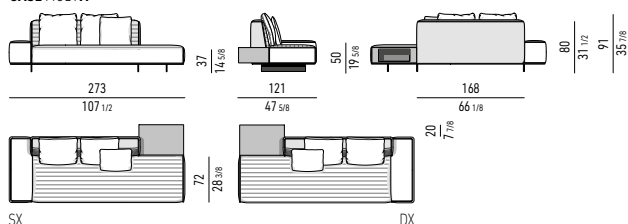

ELEMENTI DAYBED | DAYBED ELEMENTS

SPRING ELEMENTO DAYBED LOW CON CASE CM 221
SPRING DAYBED ELEMENT LOW WITH CASE CM 221

CASE MOD. A

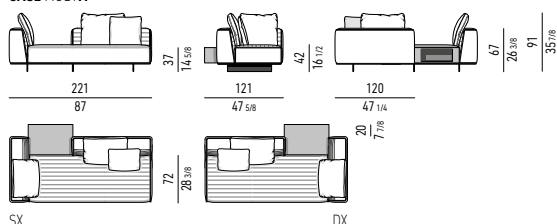

SPRING ELEMENTO DAYBED HIGH CON CASE CM 221
SPRING DAYBED ELEMENT HIGH WITH CASE CM 221

CASE MOD. A

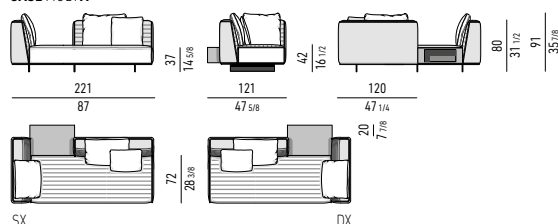

SPRING ELEMENTO DAYBED LOW MIX CON CASE CM 221
SPRING DAYBED ELEMENT LOW MIX WITH CASE CM 221

CASE MOD. A

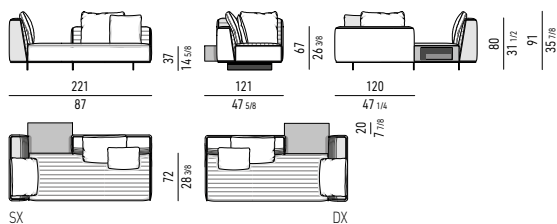

SPRING ELEMENTO DAYBED HIGH MIX CON CASE CM 221
SPRING DAYBED ELEMENT HIGH MIX WITH CASE CM 221

CASE MOD. A

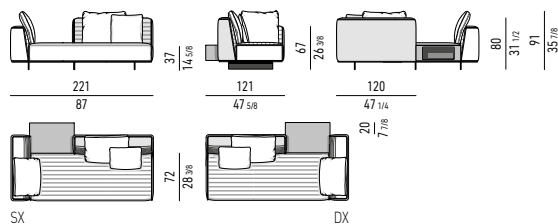

SPRING ELEMENTO DAYBED LOW CON CASE CM 245
SPRING DAYBED ELEMENT LOW WITH CASE CM 245

CASE MOD. A

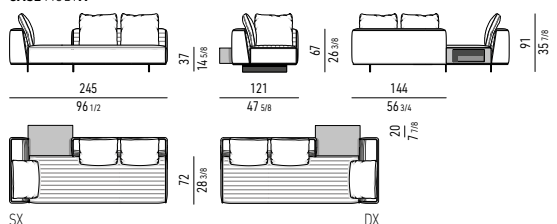

SPRING ELEMENTO DAYBED HIGH CON CASE CM 245
SPRING DAYBED ELEMENT HIGH WITH CASE CM 245

CASE MOD. A

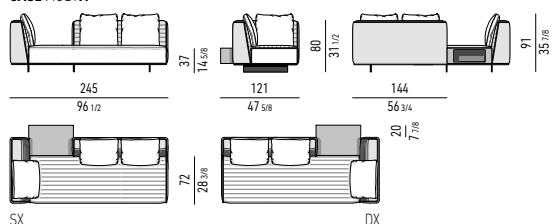

SPRING ELEMENTO DAYBED LOW MIX CON CASE CM 245
SPRING DAYBED ELEMENT LOW MIX WITH CASE CM 245

CASE MOD. A

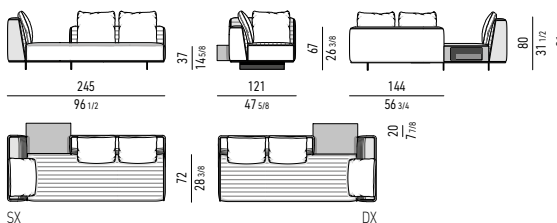

SPRING ELEMENTO DAYBED HIGH MIX CON CASE CM 245
SPRING DAYBED ELEMENT HIGH MIX WITH CASE CM 245

CASE MOD. A

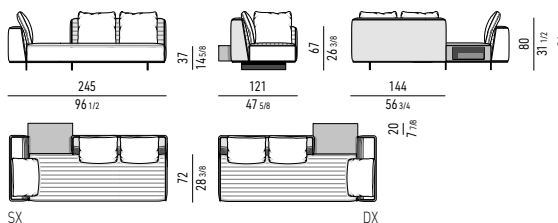

Minotti

SPRING ELEMENTO DAYBED LOW CON CASE CM 269 SPRING DAYBED ELEMENT LOW WITH CASE CM 269

CASE MOD. A

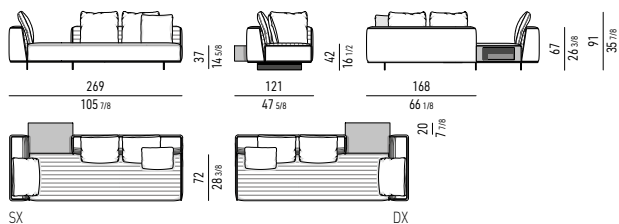

SPRING ELEMENTO DAYBED HIGH CON CASE CM 269 SPRING DAYBED ELEMENT HIGH WITH CASE CM 269

CASE MOD. A

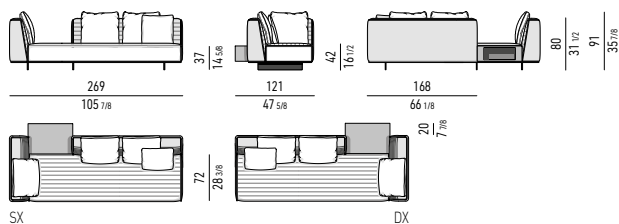

SPRING ELEMENTO DAYBED LOW MIX CON CASE CM 269 SPRING DAYBED ELEMENT LOW MIX WITH CASE CM 269

CASE MOD. A

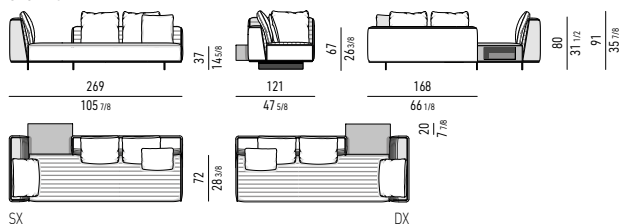

SPRING ELEMENTO DAYBED HIGH MIX CON CASE CM 269 SPRING DAYBED ELEMENT HIGH MIX WITH CASE CM 269

CASE MOD. A

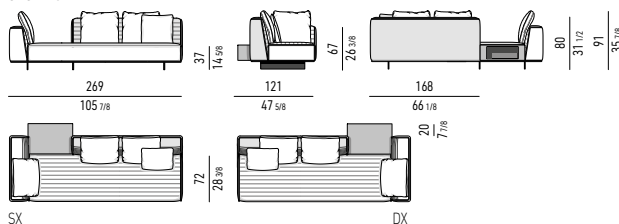

SPRING ELEMENTO DAYBED LOW CON 2 CASE CM 269 SPRING DAYBED ELEMENT LOW WITH 2 CASE CM 269

CASE MOD. A + B

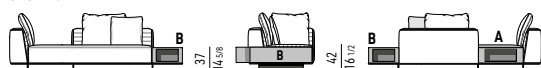

CASE MOD. A + C

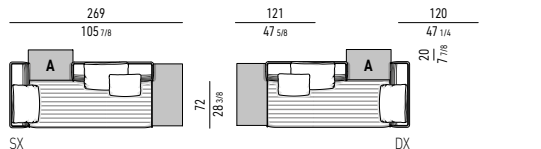
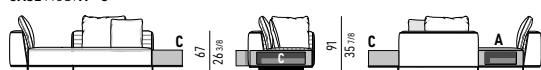

SPRING ELEMENTO DAYBED HIGH CON 2 CASE CM 269 SPRING DAYBED ELEMENT HIGH WITH 2 CASE CM 269

CASE MOD. A + B

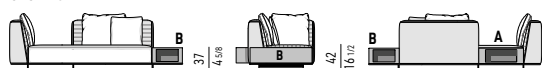

CASE MOD. A + C

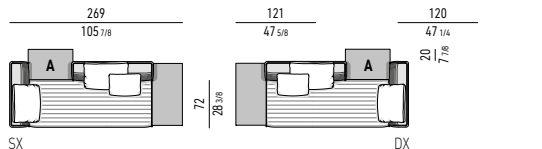
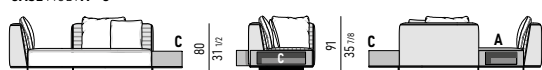

SPRING ELEMENTO DAYBED LOW MIX CON 2 CASE CM 269 SPRING DAYBED ELEMENT LOW MIX WITH 2 CASE CM 269

CASE MOD. A + B

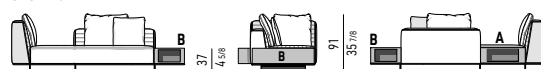

CASE MOD. A + C

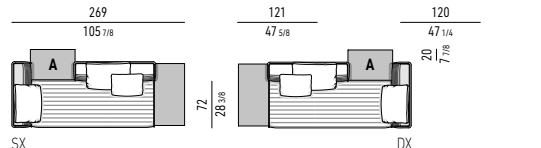

SPRING ELEMENTO DAYBED HIGH MIX CON 2 CASE CM 269 SPRING DAYBED ELEMENT HIGH MIX WITH 2 CASE CM 269

CASE MOD. A + B

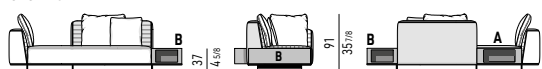

CASE MOD. A + C

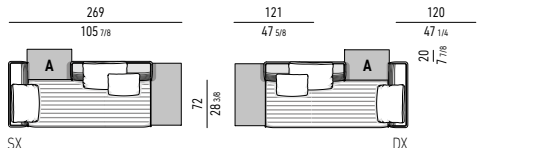
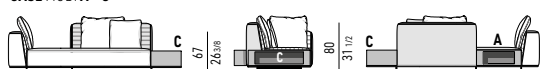

Minotti

SPRING ELEMENTO DAYBED LOW CON 2 CASE CM 293
SPRING DAYBED ELEMENT LOW WITH 2 CASE CM 293

CASE MOD. A + B

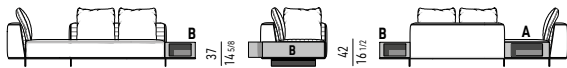

CASE MOD. A + C

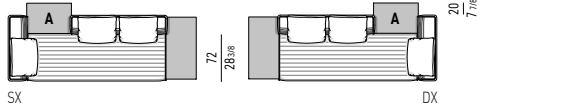
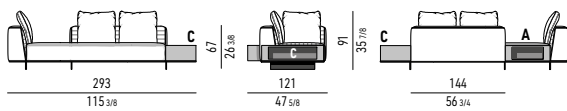

SX

DX

SPRING ELEMENTO DAYBED HIGH CON 2 CASE CM 293
SPRING DAYBED ELEMENT HIGH WITH 2 CASE CM 293

CASE MOD. A + B

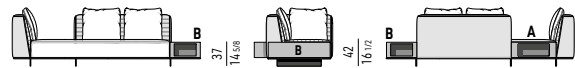

CASE MOD. A + C

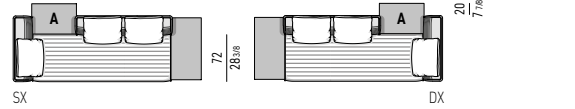
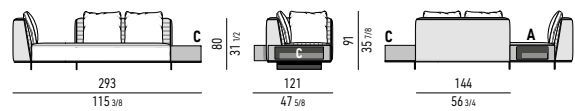

SX

DX

SPRING ELEMENTO DAYBED LOW MIX CON 2 CASE CM 293
SPRING DAYBED ELEMENT LOW MIX WITH 2 CASE CM 293

CASE MOD. A + B

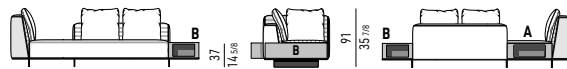

CASE MOD. A + C

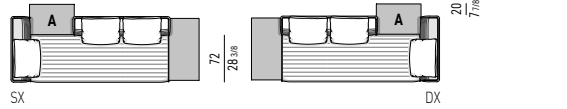
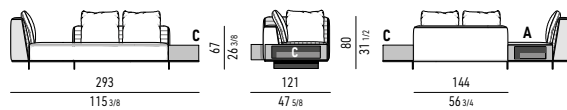

SX

DX

SPRING ELEMENTO DAYBED HIGH MIX CON 2 CASE CM 293
SPRING DAYBED ELEMENT HIGH MIX WITH 2 CASE CM 293

CASE MOD. A + B

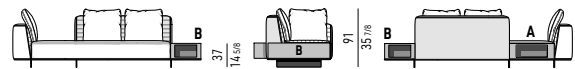

CASE MOD. A + C

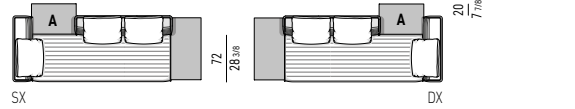
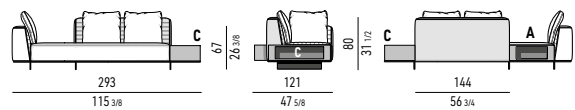

SX

DX

SPRING ELEMENTO DAYBED LOW CON 2 CASE CM 317
SPRING DAYBED ELEMENT LOW WITH 2 CASE CM 317

CASE MOD. A + B



CASE MOD. A + C

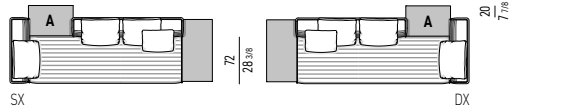
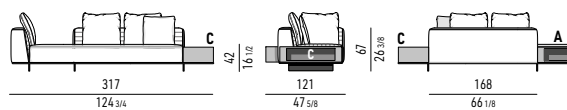

SX

DX

SPRING ELEMENTO DAYBED HIGH CON 2 CASE CM 317
SPRING DAYBED ELEMENT HIGH WITH 2 CASE CM 317

CASE MOD. A + B



CASE MOD. A + C

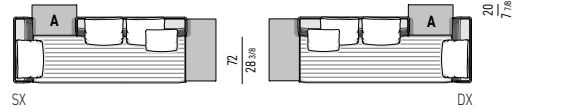
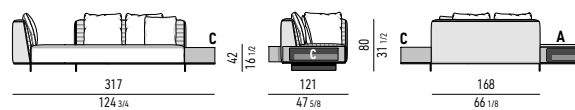

SX

DX

SPRING ELEMENTO DAYBED LOW MIX CON 2 CASE CM 317
SPRING DAYBED ELEMENT LOW MIX WITH 2 CASE CM 317

CASE MOD. A + B

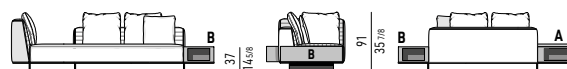

CASE MOD. A + C

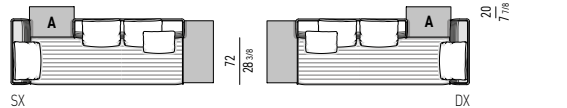
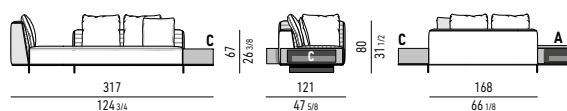

SX

DX

SPRING ELEMENTO DAYBED HIGH MIX CON 2 CASE CM 317
SPRING DAYBED ELEMENT HIGH MIX WITH 2 CASE CM 317

CASE MOD. A + B



CASE MOD. A + C

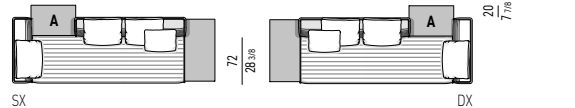
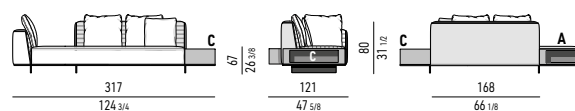

SX

DX

Minotti

ELEMENTI CENTRALI | CENTRAL ELEMENTS

SPRING ELEMENTO CENTRALE LOW CM 144
SPRING CENTRAL ELEMENT LOW CM 144

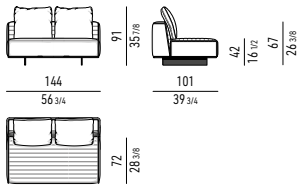

SPRING ELEMENTO CENTRALE HIGH CM 144
SPRING CENTRAL ELEMENT HIGH CM 144

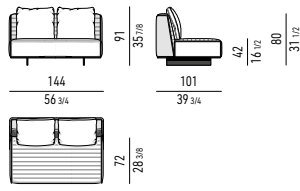

SPRING ELEMENTO CENTRALE LOW CM 168
SPRING CENTRAL ELEMENT LOW CM 168

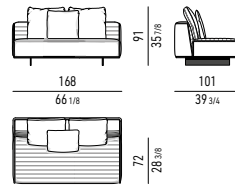

SPRING ELEMENTO CENTRALE HIGH CM 168
SPRING CENTRAL ELEMENT HIGH CM 168

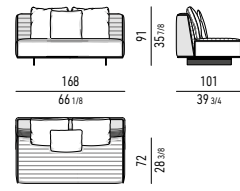

SPRING ELEMENTO CENTRALE LOW CM 192
SPRING CENTRAL ELEMENT LOW CM 192

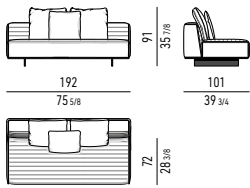

SPRING ELEMENTO CENTRALE HIGH CM 192
SPRING CENTRAL ELEMENT HIGH CM 192

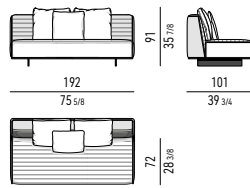

SPRING ELEMENTO CENTRALE LOW CM 216
SPRING CENTRAL ELEMENT LOW CM 216

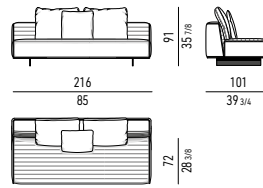

SPRING ELEMENTO CENTRALE HIGH CM 216
SPRING CENTRAL ELEMENT HIGH CM 216

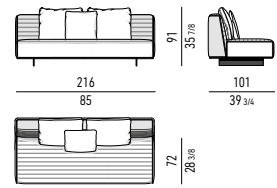

SPRING ELEMENTO CENTRALE LOW CM 240
SPRING CENTRAL ELEMENT LOW CM 240

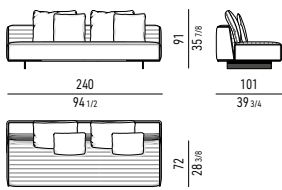

SPRING ELEMENTO CENTRALE HIGH CM 240
SPRING CENTRAL ELEMENT HIGH CM 240

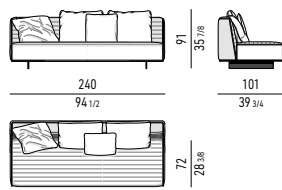

ELEMENTI CENTRALI CON "CASE" | CENTRAL ELEMENTS WITH "CASE"

SPRING ELEMENTO CENTRALE LOW CON CASE CM 192
SPRING CENTRAL ELEMENT LOW WITH CASE CM 192

CASE MOD. B



CASE MOD. C

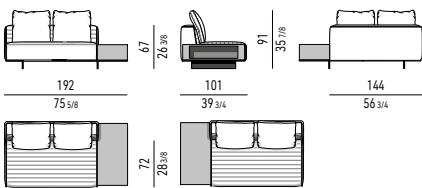

SX

DX

SPRING ELEMENTO CENTRALE HIGH CON CASE CM 192
SPRING CENTRAL ELEMENT HIGH WITH CASE CM 192

CASE MOD. B

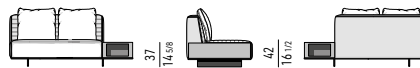

CASE MOD. C

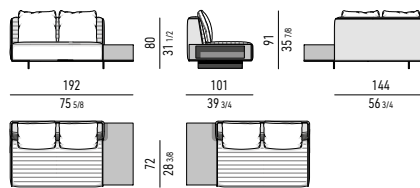

SX

DX

SPRING ELEMENTO CENTRALE LOW CON CASE CM 216
SPRING CENTRAL ELEMENT LOW WITH CASE CM 216

CASE MOD. B



CASE MOD. C

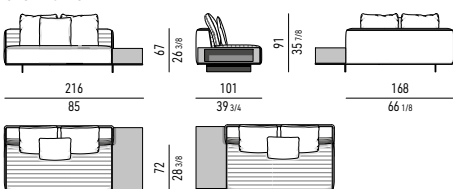

SX

DX

SPRING ELEMENTO CENTRALE HIGH CON CASE CM 216
SPRING CENTRAL ELEMENT HIGH WITH CASE CM 216

CASE MOD. B



CASE MOD. C

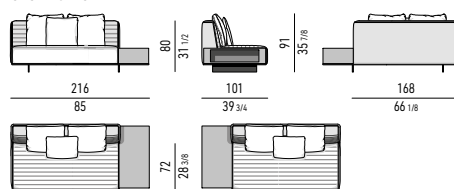

SX

DX

Minotti

SPRING ELEMENTO CENTRALE LOW CON CASE CM 240 SPRING CENTRAL ELEMENT LOW WITH CASE CM 240

CASE MOD. B



CASE MOD. C

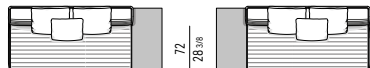
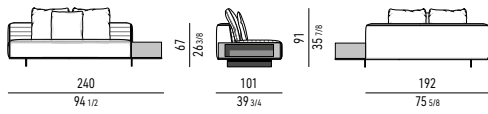

SX DX

SPRING ELEMENTO CENTRALE HIGH CON CASE CM 240 SPRING CENTRAL ELEMENT HIGH WITH CASE CM 240

CASE MOD. B



CASE MOD. C

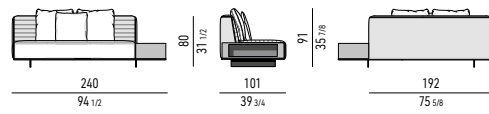

SX DX

ELEMENTI PENISOLA CON "CASE" | OPEN-END ELEMENTS WITH "CASE"

SPRING ELEMENTO PENISOLA LOW CON CASE CM 192 SPRING OPEN-END ELEMENT LOW WITH CASE CM 192

CASE MOD. A

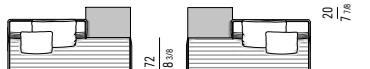
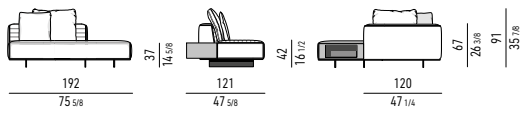

SX DX

SPRING ELEMENTO PENISOLA HIGH CON CASE CM 192 SPRING OPEN-END ELEMENT HIGH WITH CASE CM 192

CASE MOD. A

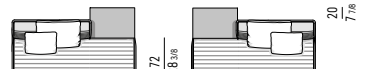
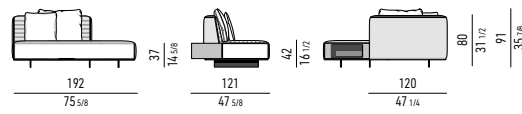

SX DX

SPRING ELEMENTO PENISOLA LOW CON CASE CM 216 SPRING OPEN-END ELEMENT LOW WITH CASE CM 216

CASE MOD. A

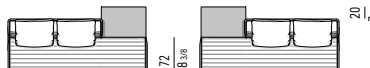
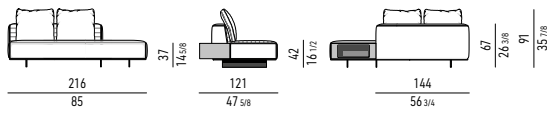

SX DX

SPRING ELEMENTO PENISOLA HIGH CON CASE CM 216 SPRING OPEN-END ELEMENT HIGH WITH CASE CM 216

CASE MOD. A

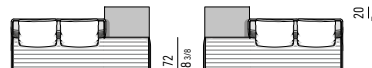
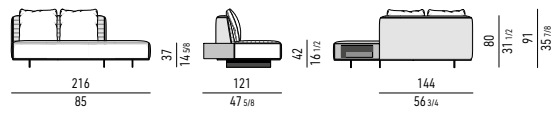

SX DX

SPRING ELEMENTO PENISOLA LOW CON CASE CM 240 SPRING OPEN-END ELEMENT LOW WITH CASE CM 240

CASE MOD. A

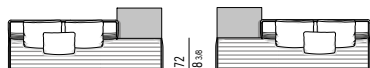
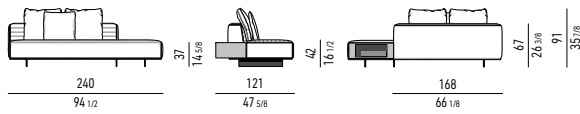

SX DX

SPRING ELEMENTO PENISOLA HIGH CON CASE CM 240 SPRING OPEN-END ELEMENT HIGH WITH CASE CM 240

CASE MOD. A

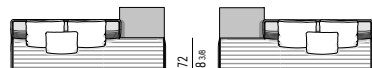
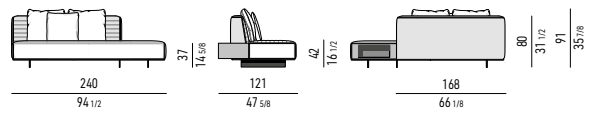

SX DX

SPRING ELEMENTO PENISOLA LOW CON 2 CASE CM 240 SPRING OPEN-END ELEMENT LOW WITH 2 CASE CM 240

CASE MOD. A + B

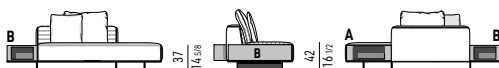

CASE MOD. A + C

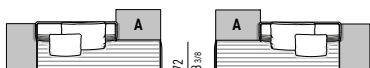
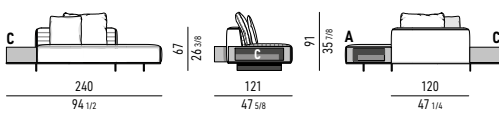

SX DX

SPRING ELEMENTO PENISOLA HIGH CON 2 CASE CM 240 SPRING OPEN-END ELEMENT HIGH WITH 2 CASE CM 240

CASE MOD. A + B

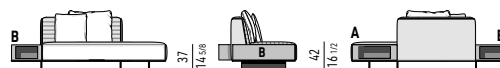

CASE MOD. A + C

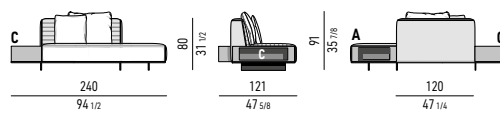

SX DX

Minotti

SPRING ELEMENTO PENISOLA LOW CON 2 CASE CM 264 SPRING OPEN-END ELEMENT LOW WITH 2 CASE CM 264

CASE MOD. A + B

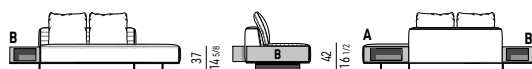

CASE MOD. A + C

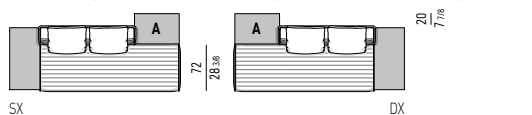
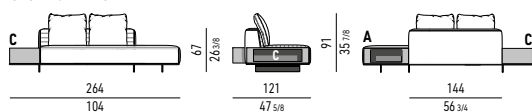

SX

DX

SPRING ELEMENTO PENISOLA HIGH CON 2 CASE CM 264 SPRING OPEN-END ELEMENT HIGH WITH 2 CASE CM 264

CASE MOD. A + B

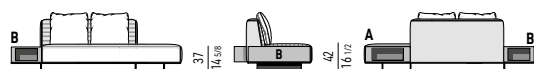

CASE MOD. A + C

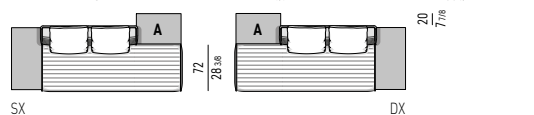
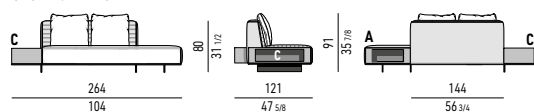

SX

DX

SPRING ELEMENTO PENISOLA LOW CON 2 CASE CM 288 SPRING OPEN-END ELEMENT LOW WITH 2 CASE CM 288

CASE MOD. A + B

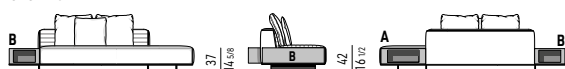

CASE MOD. A + C

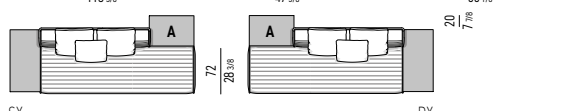
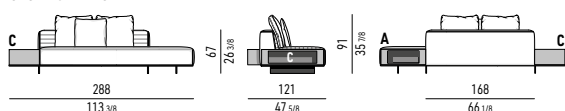

SX

DX

SPRING ELEMENTO PENISOLA HIGH CON 2 CASE CM 288 SPRING OPEN-END ELEMENT HIGH WITH 2 CASE CM 288

CASE MOD. A + B

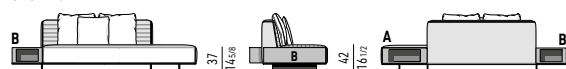

CASE MOD. A + C

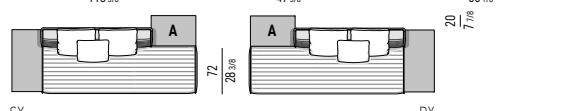
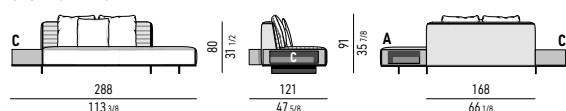

SX

DX

COUCH

SPRING COUCH LOW CM 120X173 SPRING COUCH LOW CM 120X173

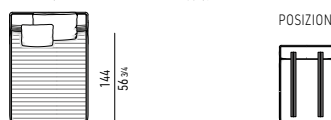
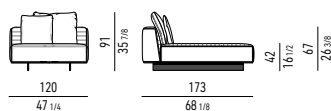

POSIZIONE BASI / BASES POSITION



CHAISE-LONGUE

SPRING CHAISE-LONGUE LOW CM 149X173 SPRING CHAISE-LONGUE LOW CM 149X173

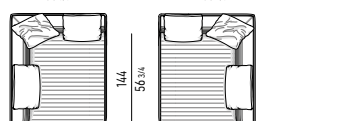
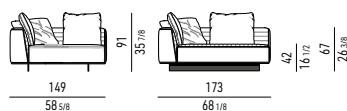

SX

DX

POSIZIONE BASI / BASES POSITION



DX

SX

ROGER SPRING BACK TO BACK 72

PROFONDITÀ DI SEDUTA CM 72 | SEAT DEPTH CM 72

SPRING BACK TO BACK ELEMENTO LOW CM 168X180
SPRING BACK TO BACK ELEMENT LOW CM 168X180

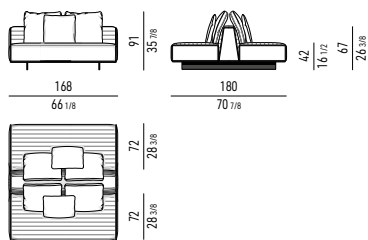

SPRING BACK TO BACK ELEMENTO HIGH CM 168X180
SPRING BACK TO BACK ELEMENT HIGH CM 168X180

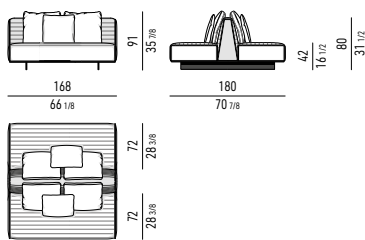

SPRING BACK TO BACK ELEMENTO LOW CM 192X180
SPRING BACK TO BACK ELEMENT LOW CM 192X180

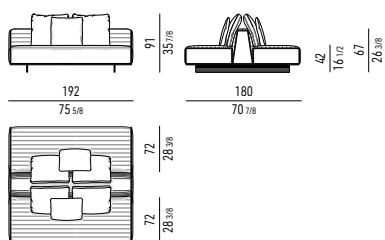

SPRING BACK TO BACK ELEMENTO HIGH CM 192X180
SPRING BACK TO BACK ELEMENT HIGH CM 192X180

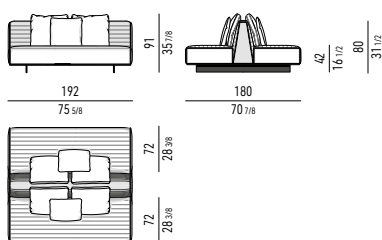

SPRING BACK TO BACK ELEMENTO LOW CM 216X180
SPRING BACK TO BACK ELEMENT LOW CM 216X180

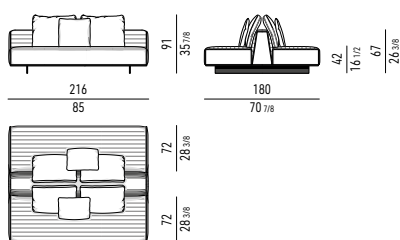

SPRING BACK TO BACK ELEMENTO HIGH CM 216X180
SPRING BACK TO BACK ELEMENT HIGH CM 216X180

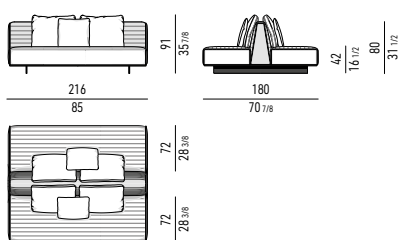

ELEMENTI "CASE" | "CASE" ELEMENTS

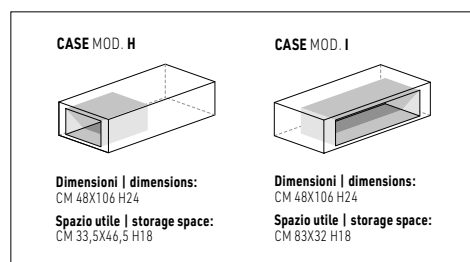

SPRING BACK TO BACK ELEMENTO LOW CON CASE CM 192X180
SPRING BACK TO BACK ELEMENT LOW WITH CASE CM 192X180

CASE MOD. H

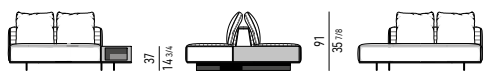

CASE MOD. I

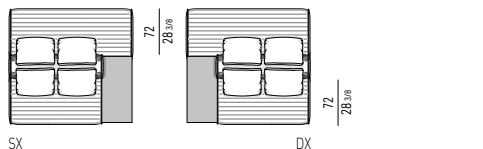
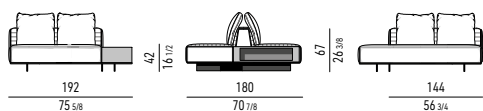

SX

DX

SPRING BACK TO BACK ELEMENTO HIGH CON CASE CM 192X180
SPRING BACK TO BACK ELEMENT HIGH WITH CASE CM 192X180

CASE MOD. H

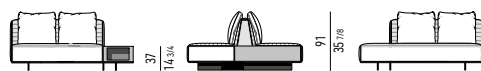

CASE MOD. I

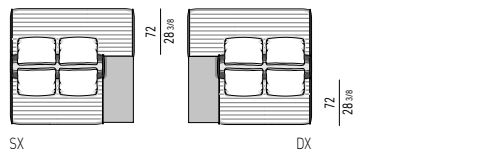
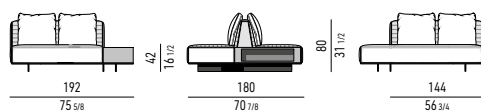

SX

DX

SPRING BACK TO BACK ELEMENTO LOW CON CASE CM 216X180
SPRING BACK TO BACK ELEMENT LOW WITH CASE CM 216X180

CASE MOD. H

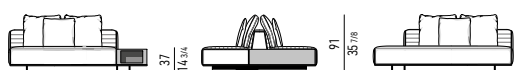

CASE MOD. I

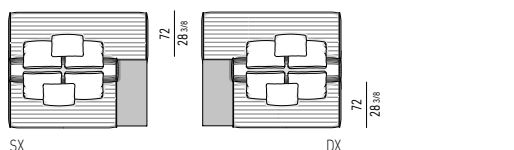
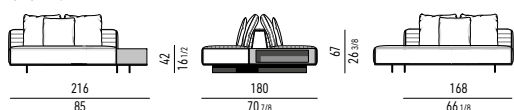

SX

DX

SPRING BACK TO BACK ELEMENTO HIGH CON CASE CM 216X180
SPRING BACK TO BACK ELEMENT HIGH WITH CASE CM 216X180

CASE MOD. H

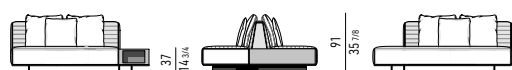

CASE MOD. I

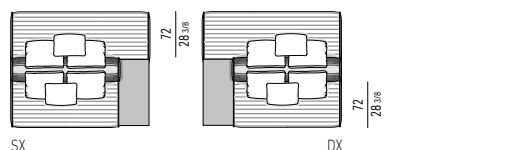
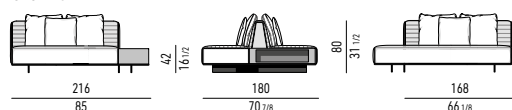

SX

DX

AVVERTENZA | WARNING

PROFONDITÀ DI SEDUTA DEGLI ELEMENTI **SPRING BACK TO BACK 72**
 SEAT DEPTH OF THE **SPRING BACK TO BACK 72** ELEMENTS

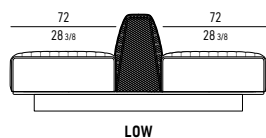

LOW

PROFONDITÀ DI SEDUTA DEGLI ELEMENTI **SPRING BACK TO BACK 72**
 SEAT DEPTH OF THE **SPRING BACK TO BACK 72** ELEMENTS

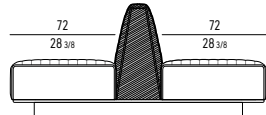

HIGH

ACCOSTAMENTO DI ELEMENTI BACK TO BACK **LOW** CON ELEMENTI SUITE O SPRING **LOW**
 JUXTAPOSITION BETWEEN BACK TO BACK **LOW** ELEMENTS AND SUITE OR SPRING **LOW** ELEMENTS

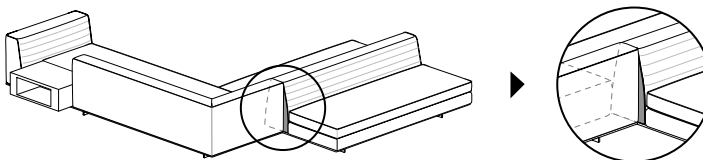

ACCOSTAMENTO DI ELEMENTI BACK TO BACK **HIGH** CON ELEMENTI SUITE O SPRING **HIGH** - **SCONSIGLIATO!**
 JUXTAPOSITION BETWEEN BACK TO BACK **HIGH** ELEMENTS AND SUITE OR SPRING **HIGH** ELEMENTS - **NOT RECOMMENDED!**

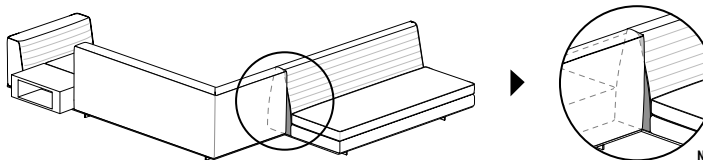

ROGER SPRING BACK TO BACK 65

PROFONDITÀ DI SEDUTA CM 65 | SEAT DEPTH CM 65

SPRING BACK TO BACK ELEMENTO LOW CM 168X166
SPRING BACK TO BACK ELEMENT LOW CM 168X166

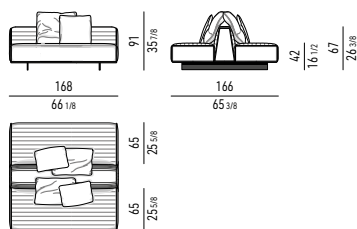

SPRING BACK TO BACK ELEMENTO HIGH CM 168X166
SPRING BACK TO BACK ELEMENT HIGH CM 168X166

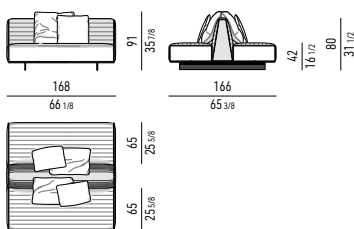

SPRING BACK TO BACK ELEMENTO LOW CM 192X166
SPRING BACK TO BACK ELEMENT LOW CM 192X166

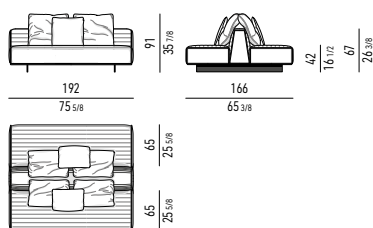

SPRING BACK TO BACK ELEMENTO HIGH CM 192X166
SPRING BACK TO BACK ELEMENT HIGH CM 192X166

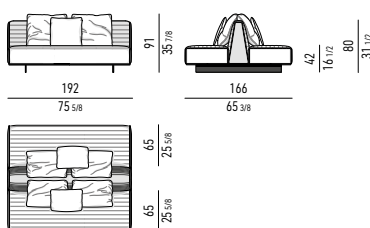

SPRING BACK TO BACK ELEMENTO LOW CM 216X166
SPRING BACK TO BACK ELEMENT LOW CM 216X166

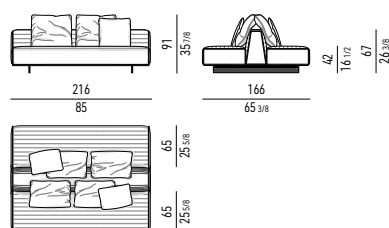

SPRING BACK TO BACK ELEMENTO HIGH CM 216X166
SPRING BACK TO BACK ELEMENT HIGH CM 216X166

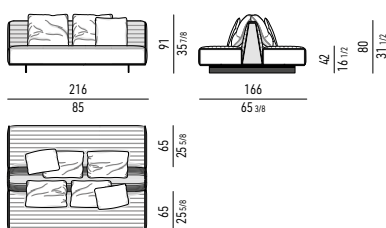

ELEMENTI "CASE" | "CASE" ELEMENTS

CASE MOD. C

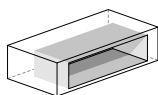

Dimensioni | dimensions:
 CM 48X98 H24

Spazio utile | storage space:
 CM 75X32 H18

CASE MOD. F

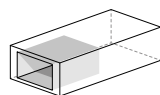

Dimensioni | dimensions:
 CM 48X98 H24

Spazio utile | storage space:
 CM 33,5X46,5 H18

SPRING BACK TO BACK ELEMENTO LOW CON CASE CM 192X166
SPRING BACK TO BACK ELEMENT LOW WITH CASE CM 192X166

CASE MOD. F

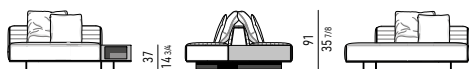

CASE MOD. C

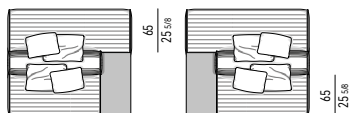
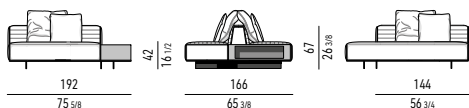

SX

DX

SPRING BACK TO BACK ELEMENTO HIGH CON CASE CM 192X166
SPRING BACK TO BACK ELEMENT HIGH WITH CASE CM 192X166

CASE MOD. F



CASE MOD. C

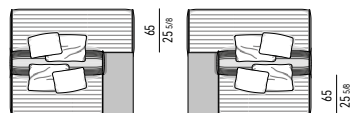
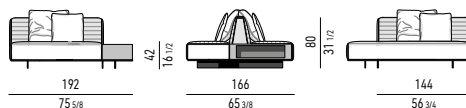

SX

DX

SPRING BACK TO BACK ELEMENTO LOW CON CASE CM 216X166
SPRING BACK TO BACK ELEMENT LOW WITH CASE CM 216X166

CASE MOD. F



CASE MOD. C

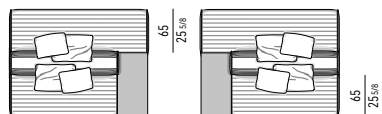
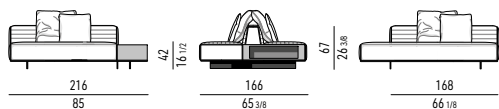

SX

DX

SPRING BACK TO BACK ELEMENTO HIGH CON CASE CM 216X166
SPRING BACK TO BACK ELEMENT HIGH WITH CASE CM 216X166

CASE MOD. F



CASE MOD. C

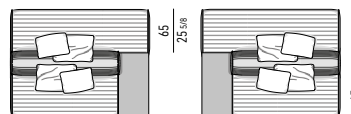
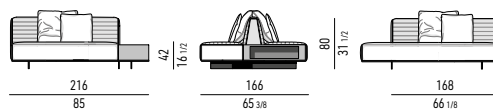

SX

DX

AVVERTENZA | WARNING

PROFONDITÀ DI SEDUTA DEGLI ELEMENTI **SPRING BACK TO BACK 65**
 SEAT DEPTH OF THE **SPRING BACK TO BACK 65** ELEMENTS

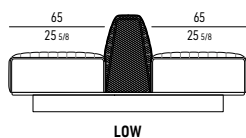

LOW

PROFONDITÀ DI SEDUTA DEGLI ELEMENTI **SPRING BACK TO BACK 65**
 SEAT DEPTH OF THE **SPRING BACK TO BACK 65** ELEMENTS

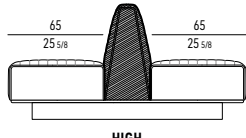

HIGH

ACCOSTAMENTO DI ELEMENTI BACK TO BACK **LOW** CON ELEMENTI SUITE O SPRING **LOW**
 JUXTAPOSITION BETWEEN BACK TO BACK **LOW** ELEMENTS AND SUITE OR SPRING **LOW** ELEMENTS

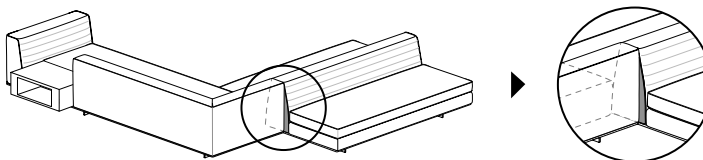

ACCOSTAMENTO DI ELEMENTI BACK TO BACK **HIGH** CON ELEMENTI SUITE O SPRING **HIGH** - **SCONSIGLIATO!**
 JUXTAPOSITION BETWEEN BACK TO BACK **HIGH** ELEMENTS AND SUITE OR SPRING **HIGH** ELEMENTS - **NOT RECOMMENDED!**

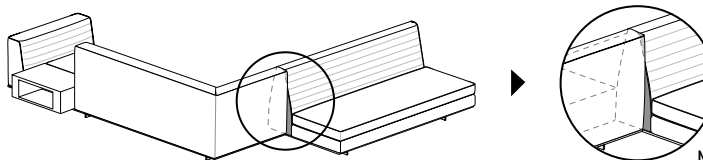

SCONSIGLIATO!
 NOT RECOMMENDED!

Minotti

ROGER SPRING SOFÀ

PROFONDITÀ CM 94 | DEPTH CM 94

SPRING SOFÀ ELEMENTO LOW CM 168
 SPRING SOFÀ ELEMENT LOW CM 168

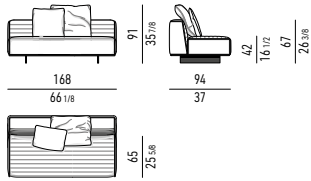

SPRING SOFÀ ELEMENTO LOW CM 192
 SPRING SOFÀ ELEMENT LOW CM 192

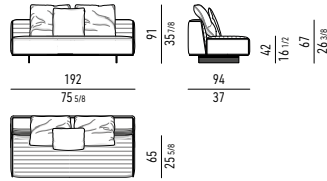

SPRING SOFÀ ELEMENTO LOW CON CASE CM 192
 SPRING SOFÀ ELEMENT LOW WITH CASE CM 192

CASE MOD. D



CASE MOD. E

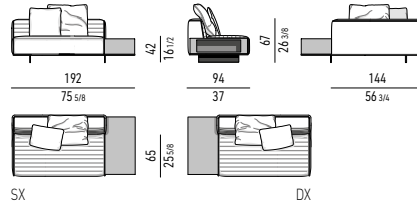

SPRING SOFÀ ELEMENTO LOW CON CASE CM 216
 SPRING SOFÀ ELEMENT LOW WITH CASE CM 216

CASE MOD. D



CASE MOD. E

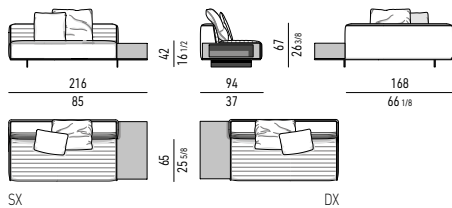

SPRING SOFÀ ELEMENTO LOW CON CASE CM 240
 SPRING SOFÀ ELEMENT LOW WITH CASE CM 240

CASE MOD. D



CASE MOD. E

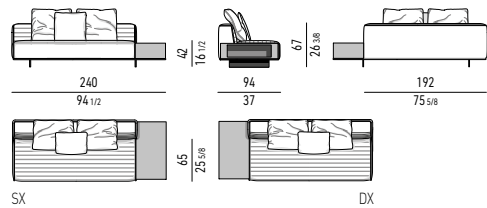

SPRING SOFÀ ELEMENTO PENISOLA LOW CON CASE CM 192
 SPRING SOFÀ OPEN-END ELEMENT LOW WITH CASE CM 192

CASE MOD. A

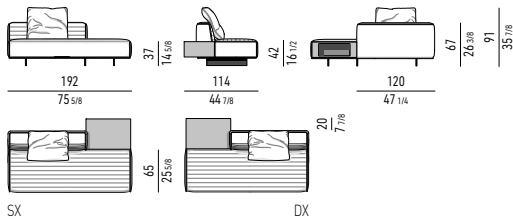

SPRING SOFÀ ELEMENTO PENISOLA LOW CON CASE CM 216
 SPRING SOFÀ OPEN-END ELEMENT LOW WITH CASE CM 216

CASE MOD. A

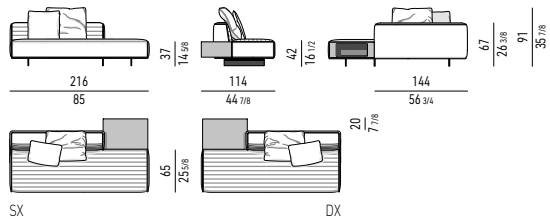

ELEMENTI "CASE" | "CASE" ELEMENTS

CASE MOD. A	CASE MOD. D	CASE MOD. E
Dimensioni dimensions: CM 70X48 H24	Dimensioni dimensions: CM 48X90 H24	Dimensioni dimensions: CM 48X90 H24
Spazio utile storage space: CM 47X32 H18	Spazio utile storage space: CM 33,5X44 H18 (x2)	Spazio utile storage space: CM 67X32 H18

SPRING SOFÀ ELEMENTO PENISOLA LOW CON CASE CM 240
SPRING SOFÀ OPEN-END ELEMENT LOW WITH CASE CM 240

CASE MOD. A

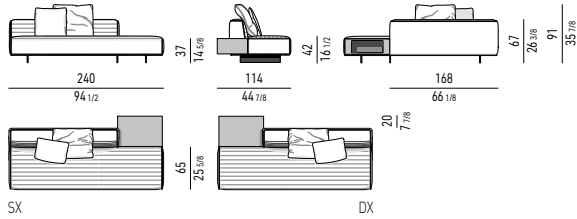

SPRING SOFÀ ELEMENTO PENISOLA LOW CON 2 CASE CM 240
SPRING SOFÀ OPEN-END ELEMENT LOW WITH 2 CASE CM 240

CASE MOD. A + D

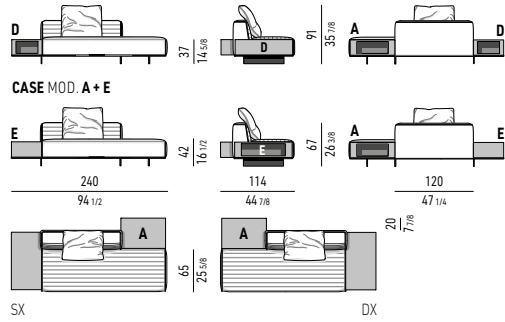

SPRING SOFÀ ELEMENTO PENISOLA LOW CON 2 CASE CM 264
SPRING SOFÀ OPEN-END ELEMENT LOW WITH 2 CASE CM 264

CASE MOD. A + D

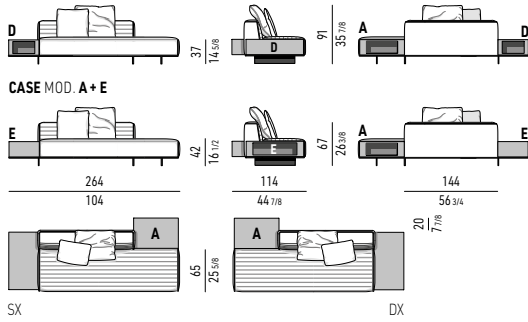

SPRING SOFÀ ELEMENTO PENISOLA LOW CON 2 CASE CM 288
SPRING SOFÀ OPEN-END ELEMENT LOW WITH 2 CASE CM 288

CASE MOD. A + D

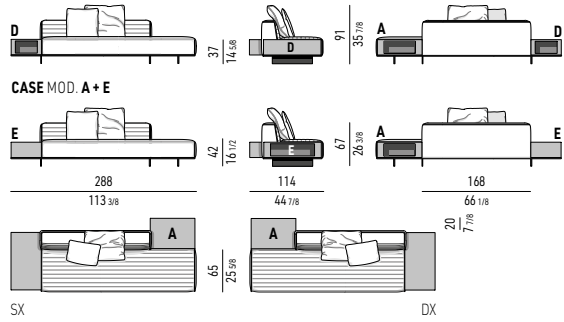

ROGER SPRING UNIT

POLTRONE | ARMCHAIRS

SPRING UNIT POLTRONA CM 72X94
SPRING UNIT ARMCHAIR CM 72X94

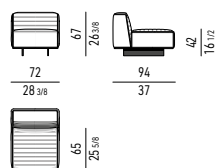

SPRING UNIT POLTRONA CM 72X101
SPRING UNIT ARMCHAIR CM 72X101

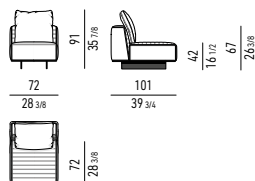

DAYBED | DAYBED

SPRING UNIT DAYBED CM 72X173
SPRING UNIT DAYBED CM 72X173

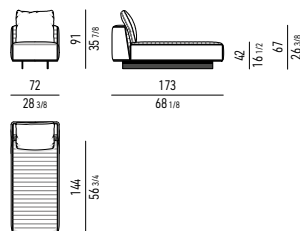

PANCHE | BENCHES

SPRING UNIT PANCA CM 120X52
SPRING UNIT BENCH CM 120X52

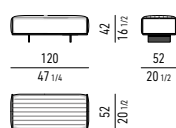

SPRING UNIT PANCA CM 120X65
SPRING UNIT BENCH CM 120X65

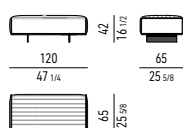

SPRING UNIT PANCA CM 144X52
SPRING UNIT BENCH CM 144X52

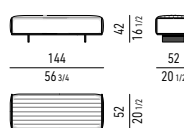

SPRING UNIT PANCA CM 144X65
SPRING UNIT BENCH CM 144X65

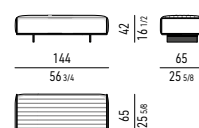

SPRING UNIT PANCA CM 144X72
SPRING UNIT BENCH CM 144X72

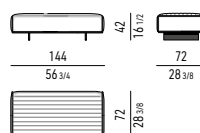

SPRING UNIT PANCA CM 168X39
SPRING UNIT BENCH CM 168X39

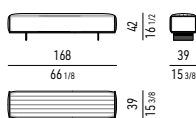

SPRING UNIT PANCA CM 168X52
SPRING UNIT BENCH CM 168X52

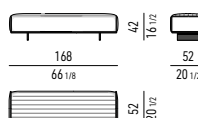

SPRING UNIT PANCA CM 168X65
SPRING UNIT BENCH CM 168X65

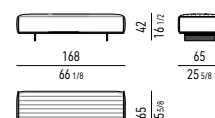

SPRING UNIT PANCA CON CASE CM 144X65
SPRING UNIT BENCH WITH CASE CM 144X65

CASE MOD. G

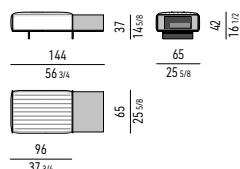

SPRING UNIT PANCA CON CASE CM 168X65
SPRING UNIT BENCH WITH CASE CM 168X65

CASE MOD. G

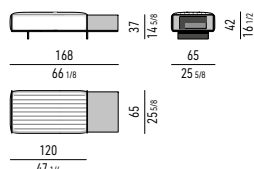

SPRING UNIT PANCA CON CASE CM 192X65
SPRING UNIT BENCH WITH CASE CM 192X65

CASE MOD. G

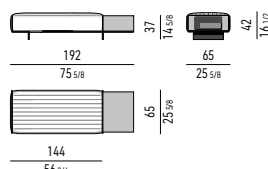

POUF | OTTOMANS

SPRING UNIT POUF CM 109X109
SPRING UNIT OTTOMAN CM 109X109

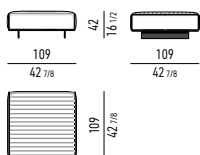

SPRING UNIT POUF CM 101X101
SPRING UNIT OTTOMAN CM 101X101

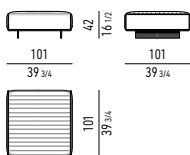

SPRING UNIT POUF CM 94X94
SPRING UNIT OTTOMAN CM 94X94

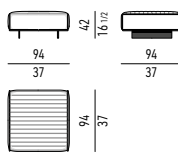

SPRING UNIT POUF CM 72X72
SPRING UNIT OTTOMAN CM 72X72

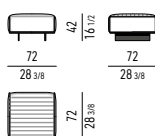

SPRING UNIT POUF CM 72X65
SPRING UNIT OTTOMAN CM 72X65

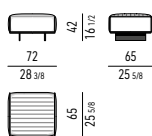

SPRING UNIT POUF CM 65X65
SPRING UNIT OTTOMAN CM 65X65

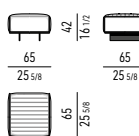

ELEMENTO "CASE" | "CASE" ELEMENT

CASE MOD. G

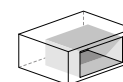

Dimensioni | dimensions:
CM 48X63 H24
Spazio utile | storage space:
CM 40X32 H18

BRACCIOLO AMOVIBILE REMOVABLE ARMREST

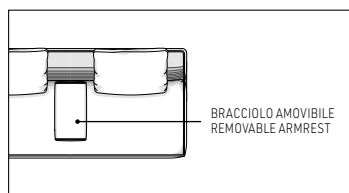
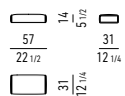

POGGIATESTA | HEADREST

POGGIATESTA OPTIONAL **ROGER** CM 72
ROGER OPTIONAL HEADREST CM 72

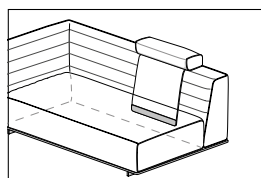
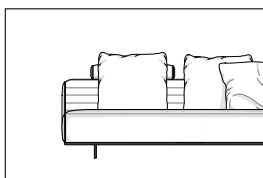
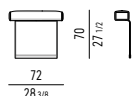

DA UTILIZZARE ESCLUSIVAMENTE CON ELEMENTI "LOW"
TO USE ONLY WITH "LOW" ELEMENTS

CUSCINI SCHIENALE OPTIONAL OPTIONAL BACKREST CUSHIONS

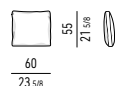
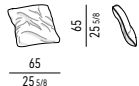
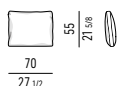

CUSCINO OPTIONAL OPTIONAL CUSHION

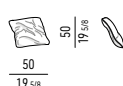

MIRAGE MINOTTI STUDIO DESIGN

CUSCINI OPTIONAL "MIRAGE"
"MIRAGE" OPTIONAL CUSHIONS

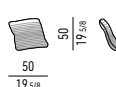
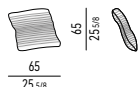

VISTA FRONTALE E POSTERIORE DEI CUSCINI "MIRAGE"
FRONT AND BACK VIEW OF THE "MIRAGE" CUSHIONS

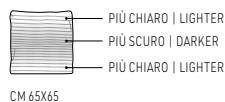

CM 65X65

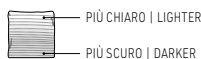

CM 50x50

DOUBLE MINOTTI STUDIO DESIGN

CUSCINI OPTIONAL "DOUBLE"
"DOUBLE" OPTIONAL CUSHIONS

FRONTE | FRONT

RETRO | BACK



TESSUTO | FABRIC
PELLE | LEATHER



FRONTE | FRONT

RETRO | BACK



TESSUTO | FABRIC
PELLE | LEATHER



VISTA FRONTALE DEI CUSCINI "DOUBLE" CONFEZIONATI CON TESSUTO "MIRAGE"
FRONT VIEW OF THE "DOUBLE" CUSHIONS UPHOLSTERED IN "MIRAGE" FABRIC

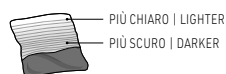

CM 65X65

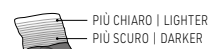

CM 50x50

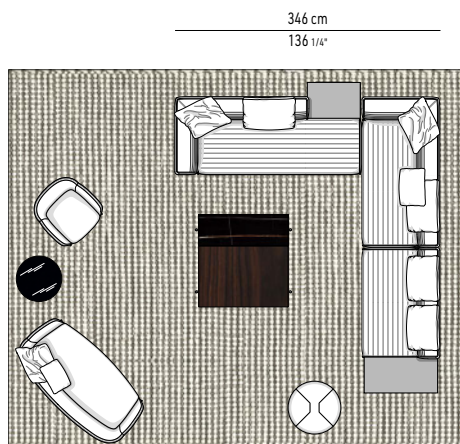

- A**
- 1 SPRING elemento terminale penisola LOW sx con CASE mod. A cm 245x121 H91
 - 1 SPRING elemento terminale LOW sx cm 197x101 H91
 - 1 SPRING elemento centrale LOW sx con CASE mod. C cm 192x101 H91
 - 1 Belt - divano Lounge semicurvo cm 183x94 H71
 - 1 Belt - poltrona cm 78x81 H71
 - 1 Tuffet - pouf Ø cm 70 H40
 - 1 Jigger - tavolino Ø cm 60 H45
 - 1 Superquadra - tavolino cm 122x128 H22
 - 1 Osaka - tappeto cm 600x500
 - 1 SPRING open-end element with armrest LOW sx with CASE mod. A cm 245x121 H91
 - 1 SPRING element with 1 armrest LOW sx cm 197x101 H91
 - 1 SPRING central element LOW sx with CASE mod. C cm 192x101 H91
 - 1 Belt - semi-round Lounge Sofa cm 183x94 H71
 - 1 Belt - armchair cm 78x81 H71
 - 1 Tuffet - ottoman Ø cm 70 H40
 - 1 Jigger - side table Ø cm 60 H45
 - 1 Superquadra - coffee table cm 122x128 H22
 - 1 Osaka - rug cm 600x500
 - 1 SPRING halbinselement mit Armlehne LOW sx mit CASE mod. A cm 245x121 H91
 - 1 SPRING endelement mit 1 Armlehne LOW sx cm 197x101 H91
 - 1 SPRING mitteelement LOW sx mit CASE mod. C cm 192x101 H91
 - 1 Belt - halbrundes Lounge Sofa cm 183x94 H71
 - 1 Belt - Sessel cm 78x81 H71
 - 1 Tuffet - Hocker Ø cm 70 H40
 - 1 Jigger - Beistelltisch Ø cm 60 H45
 - 1 Superquadra - Beistelltisch cm 122x128 H22
 - 1 Osaka - Teppich cm 600x500
 - 1 SPRING élément Îlot avec accoudoir LOW sx avec CASE mod. A cm 245x121 H91
 - 1 SPRING élément avec 1 accoudoir LOW sx cm 197x101 H91
 - 1 SPRING élément central LOW sx avec CASE mod. C cm 192x101 H91
 - 1 Belt - canapé demi-rond Lounge cm 183x94 H71
 - 1 Belt - fauteuil cm 78x81 H71
 - 1 Tuffet - pouf Ø cm 70 H40
 - 1 Jigger - petite table Ø cm 60 H45
 - 1 Superquadra - petite table cm 122x128 H22
 - 1 Osaka - Tapis cm 600x500

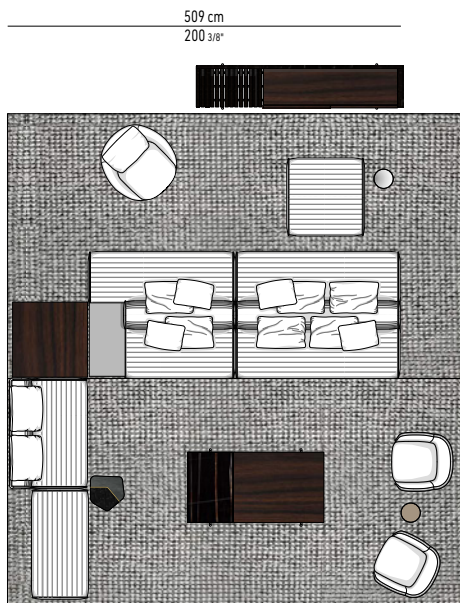

- B**
- 1 SPRING BACK TO BACK elemento LOW cm 216x166 H91
 - 1 SPRING BACK TO BACK elemento LOW dx con CASE mod. F cm 192x166 H91
 - 1 Roger - tavolino con 1 vano interno cm 99x99 H37
 - 1 SPRING elemento centrale LOW cm 144x101 H91
 - 1 SPRING UNIT panca cm 144x72 H42
 - 1 SPRING UNIT pouf cm 101x101 H42
 - 1 Lido - poltrona con base cm 93x99 H85
 - 2 Belt - poltrone cm 78x81 H71
 - 1 Superquadra - tavolino cm 180x104,5 H22
 - 1 Brink - tavolino cm 46x44,5 H45
 - 1 Pilotis - tavolino Ø cm 27 H45
 - 1 Pilotis - tavolino Ø cm 27 H55
 - 1 Superquadra - contenitore orizzontale Living/Tv sx cm 273,5x60 H48,5
 - 1 Osaka - tappeto cm 600x350
 - 1 Osaka - tappeto cm 600x300
 - 1 SPRING BACK TO BACK elemento LOW cm 216x166 H91
 - 1 SPRING BACK TO BACK elemento LOW dx with CASE mod. F cm 192x166 H91
 - 1 Roger - coffee table with 1 inner compartment cm 99x99 H37
 - 1 SPRING central element LOW cm 144x101 H91
 - 1 SPRING UNIT bench cm 144x72 H42
 - 1 SPRING UNIT ottoman cm 101x101 H42
 - 1 Lido - armchair with base cm 93x99 H85
 - 2 Belt - armchairs cm 78x81 H71
 - 1 Superquadra - coffee table cm 180x104,5 H22
 - 1 Brink - side table cm 46x44,5 H45
 - 1 Pilotis - side table Ø cm 27 H45
 - 1 Pilotis - side table Ø cm 27 H55
 - 1 Superquadra - Living/Tv horizontal sideboard sx cm 273,5x60 H48,5
 - 1 Osaka - rug cm 600x350
 - 1 Osaka - rug cm 600x300
 - 1 SPRING BACK TO BACK Element LOW cm 216x166 H91
 - 1 SPRING BACK TO BACK Element LOW dx mit CASE mod. F cm 192x166 H91
 - 1 Roger - Beistelltisch mit 1 Innenfach cm 99x99 H37
 - 1 SPRING Mittelelement LOW cm 144x101 H91
 - 1 SPRING UNIT Bank cm 144x72 H42
 - 1 SPRING UNIT Hocker cm 101x101 H42
 - 1 Lido - Sessel mit Sockel cm 93x99 H85
 - 2 Belt - Sessel cm 78x81 H71
 - 1 Superquadra - Beistelltisch cm 180x104,5 H22
 - 1 Brink - Beistelltisch cm 46x44,5 H45
 - 1 Pilotis - Beistelltisch Ø cm 27 H45
 - 1 Pilotis - Beistelltisch Ø cm 27 H55
 - 1 Superquadra - Living/Tv horizontales Sideboard sx cm 273,5x60 H48,5
 - 1 Osaka - Teppich cm 600x350
 - 1 Osaka - Teppich cm 600x300
 - 1 SPRING BACK TO BACK élément LOW cm 216x166 H91
 - 1 SPRING BACK TO BACK élément LOW dx avec CASE mod. F cm 192x166 H91
 - 1 Roger - petite table avec 1 rangement cm 99x99 H37
 - 1 SPRING élément central LOW cm 144x101 H91
 - 1 SPRING UNIT banc cm 144x72 H42
 - 1 SPRING UNIT pouf cm 101x101 H42
 - 1 Lido - fauteuil avec piètement cm 93x99 H85
 - 2 Belt - fauteuils cm 78x81 H71
 - 1 Superquadra - petite table cm 180x104,5 H22
 - 1 Brink - petite table cm 46x44,5 H45
 - 1 Pilotis - petite table Ø cm 27 H45
 - 1 Pilotis - petite table Ø cm 27 H55
 - 1 Superquadra - bahut horizontal Living/Tv sx cm 273,5x60 H48,5
 - 1 Osaka - tapis cm 600x350
 - 1 Osaka - tapis cm 600x300

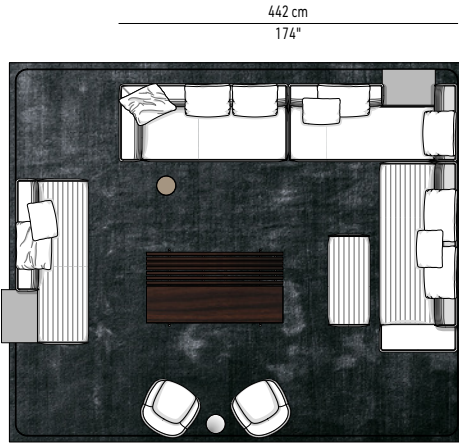

- C**
- | | |
|---|--|
| 1 SUITE elemento terminale LOW sx cm 221x101 H91 | 1 SUITE endelement mit 1 Armlehne LOW sx cm 221x101 H91 |
| 1 SUITE elemento Daybed LOW MIX dx con CASE mod. A cm 221x121 H91 | 1 SUITE Daybed Element LOW MIX dx mit CASE mod. A cm 221x121 H91 |
| 1 SPRING elemento terminale HIGH SQUARE dx cm 249x101 H91 | 1 SPRING endelement mit 1 armlehne HIGH SQUARE dx cm 249x101 H91 |
| 1 SPRING SOFÀ elemento penisola LOW dx con CASE mod. A cm 216x114 H91 | 1 SPRING SOFÀ Halbinselement LOW dx mit CASE mod. A cm 216x114 H91 |
| 1 SPRING UNIT panca cm 120x52 H42 | 1 SPRING UNIT bank cm 120x52 H42 |
| 2 Belt - poltrone Lounge cm 73x72 H71 | 2 Belt - Lounge Sessel cm 73x72 H71 |
| 1 Superquadra - tavolino cm 180x104,5 H22 | 1 Superquadra - Beistelltisch cm 180x104,5 H22 |
| 1 Pilotis - tavolino Ø cm 27 H45 | 1 Pilotis - Beistelltisch Ø cm 27 H45 |
| 1 Pilotis - tavolino Ø cm 27 H55 | 1 Pilotis - Beistelltisch Ø cm 27 H55 |
| 1 Outline - tappeto cm 600x500 | 1 Outline - Teppich cm 600x500 |
-
- | | |
|---|---|
| 1 SUITE element with 1 armrest LOW sx cm 221x101 H91 | 1 SUITE élément avec 1 accoudoir LOW sx cm 221x101 H91 |
| 1 SUITE Daybed element LOW MIX dx with CASE mod. A cm 221x121 H91 | 1 SUITE élément Daybed LOW MIX dx avec CASE mod. A cm 221x121 H91 |
| 1 SPRING element with 1 armrest HIGH SQUARE dx cm 249x101 H91 | 1 SPRING élément avec 1 accoudoir HIGH SQUARE dx cm 249x101 H91 |
| 1 SPRING SOFÀ open-end element LOW dx with CASE mod. A cm 216x114 H91 | 1 SPRING SOFÀ élément îlot LOW dx avec CASE mod. A cm 216x114 H91 |
| 1 SPRING UNIT bench cm 120x52 H42 | 1 SPRING UNIT banc cm 120x52 H42 |
| 2 Belt - Lounge armchairs cm 73x72 H71 | 2 Belt - fauteuils Lounge cm 73x72 H71 |
| 1 Superquadra - coffee table cm 180x104,5 H22 | 1 Superquadra - petite table cm 180x104,5 H22 |
| 1 Pilotis - side table Ø cm 27 H45 | 1 Pilotis - petite table Ø cm 27 H45 |
| 1 Pilotis - side table Ø cm 27 H55 | 1 Pilotis - petite table Ø cm 27 H55 |
| 1 Outline - rug cm 600x500 | 1 Outline - tapis cm 600x500 |

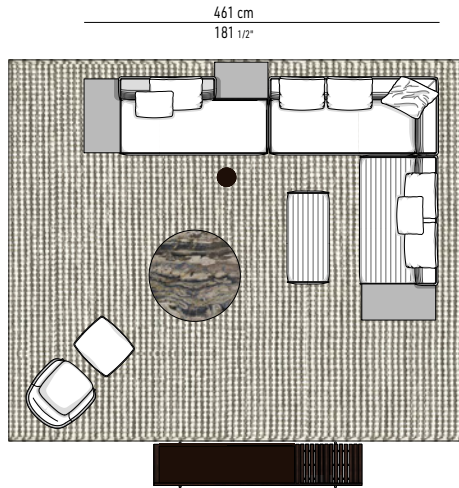

- D**
- | | |
|---|---|
| 1 SUITE elemento penisola HIGH sx con 2 CASE mod. A+B cm 240x121 H91 | 1 SUITE halbinselement HIGH sx mit 2 CASE mod. A+B cm 240x121 H91 |
| 1 SUITE elemento terminale LOW dx cm 221x101 H91 | 1 SUITE endelement mit 1 Armlehne LOW dx cm 221x101 H91 |
| 1 SPRING elemento centrale LOW sx con CASE mod. C cm 216x101 H91 | 1 SPRING mittelelement LOW sx mit CASE mod. C cm 216x101 H91 |
| 1 SPRING UNIT panca cm 120x52 H42 | 1 SPRING UNIT Bank cm 120x52 H42 |
| 1 Belt - bergère cm 78x84 H93 | 1 Belt - Bergère cm 78x84 H93 |
| 1 Belt - poggiapiedi cm 64x58 H42 | 1 Belt - Hocker cm 64x58 H42 |
| 1 Jigger - tavolino Ø cm 120 H30 | 1 Jigger - Beistelltisch Ø cm 120 H30 |
| 1 Pilotis - tavolino Ø cm 27 H45 | 1 Pilotis - Beistelltisch Ø cm 27 H45 |
| 1 Superquadra - contenitore orizzonale Living/Tv sx cm 273,5x60 H48,5 | 1 Superquadra - Living/Tv horizontales Sideboard sx cm 273,5x60 H48,5 |
| 1 Osaka - tappeto cm 600x500 | 1 Osaka - Teppich cm 600x500 |
-
- | | |
|--|--|
| 1 SUITE open-end element HIGH sx with 2 CASE mod. A+B cm 240x121 H91 | 1 SUITE élément îlot HIGH sx avec 2 CASE mod. A+B cm 240x121 H91 |
| 1 SUITE element with 1 armrest LOW dx cm 221x101 H91 | 1 SUITE élément avec 1 accoudoir LOW dx cm 221x101 H91 |
| 1 SPRING central element LOW sx with CASE mod. C cm 216x101 H91 | 1 SPRING élément central LOW sx avec CASE mod. C cm 216x101 H91 |
| 1 SPRING UNIT bench cm 120x52 H42 | 1 SPRING UNIT banc cm 120x52 H42 |
| 1 Belt - bergère cm 78x84 H93 | 1 Belt - bergère cm 78x84 H93 |
| 1 Belt - footstool cm 64x58 H42 | 1 Belt - repose-pied cm 64x58 H42 |
| 1 Jigger - coffee table Ø cm 120 H30 | 1 Jigger - petite table Ø cm 120 H30 |
| 1 Pilotis - side table Ø cm 27 H45 | 1 Pilotis - petite table Ø cm 27 H45 |
| 1 Superquadra - Living/Tv horizontal sideboard sx cm 273,5x60 H48,5 | 1 Superquadra - bahut horizontal Living/Tv sx cm 273,5x60 H48,5 |
| 1 Osaka - rug cm 600x500 | 1 Osaka - tapis cm 600x500 |

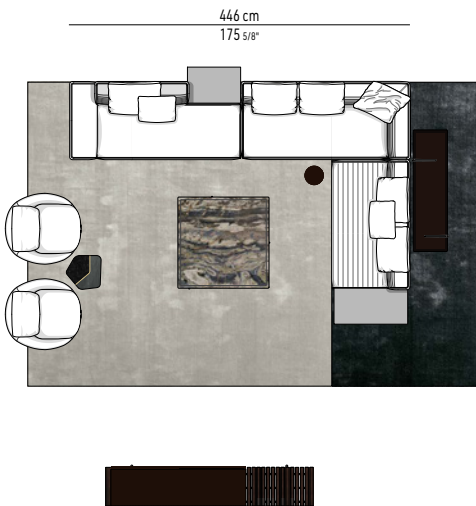

- E**
- | | |
|---|---|
| 1 SUITE elemento terminale penisola HIGH SQUARE sx con CASE mod. A cm 225x121 H91 | 1 SUITE halbinselement mit 1 Armlehne HIGH SQUARE sx mit CASE mod. A cm 225x121 H91 |
| 1 SUITE elemento terminale LOW dx cm 221x101 H91 | 1 SUITE endelement mit 1 Armlehne LOW dx cm 221x101 H91 |
| 1 SPRING elemento centrale LOW sx con CASE mod. C cm 216x101 H91 | 1 SPRING mittelelement LOW sx mit CASE mod. C cm 216x101 H91 |
| 2 Lido - poltrone cm 93x99 H85 | 2 Lido - Sessel cm 93x99 H85 |
| 1 Brink - tavolino cm 46x44,5 H45 | 1 Brink - Beistelltisch cm 46x44,5 H45 |
| 1 Keel - tavolino cm 120x120 H30 | 1 Keel - Beistelltisch cm 120x120 H30 |
| 1 Pilotis - tavolino Ø cm 27 H45 | 1 Pilotis - Beistelltisch Ø cm 27 H45 |
| 1 Keel - consolle cm 160x45 H58 | 1 Keel - Konsole cm 160x45 H58 |
| 1 Superquadra - contenitore orizzonale Living/Tv sx cm 273,5x60 H48,5 | 1 Superquadra - Living/Tv horizontales Sideboard sx cm 273,5x60 H48,5 |
| 1 Dibbets Flag - tappeto cm 600x400 | 1 Dibbets Flag - Teppich cm 600x400 |
-
- | | |
|--|--|
| 1 SUITE open-end element with 1 armrest HIGH SQUARE sx with CASE mod. A cm 225x121 H91 | 1 SUITE élément îlot avec 1 accoudoir HIGH SQUARE sx avec CASE mod. A cm 225x121 H91 |
| 1 SUITE element with 1 armrest LOW dx cm 221x101 H91 | 1 SUITE élément avec 1 accoudoir LOW dx cm 221x101 H91 |
| 1 SPRING central element LOW sx with CASE mod. C cm 216x101 H91 | 1 SPRING élément central LOW sx avec CASE mod. C cm 216x101 H91 |
| 2 Lido - armchairs cm 93x99 H85 | 2 Lido - fauteuils cm 93x99 H85 |
| 1 Brink - side table cm 46x44,5 H45 | 1 Brink - petite table cm 46x44,5 H45 |
| 1 Keel - coffee table cm 120x120 H30 | 1 Keel - petite table cm 120x120 H30 |
| 1 Pilotis - side table Ø cm 27 H45 | 1 Pilotis - petite table Ø cm 27 H45 |
| 1 Keel - console table cm 160x45 H58 | 1 Keel - console cm 160x45 H58 |
| 1 Superquadra - Living/Tv horizontal sideboard sx cm 273,5x60 H48,5 | 1 Superquadra - bahut horizontal Living/Tv sx cm 273,5x60 H48,5 |
| 1 Dibbets Flag - rug cm 600x400 | 1 Dibbets Flag - tapis cm 600x400 |

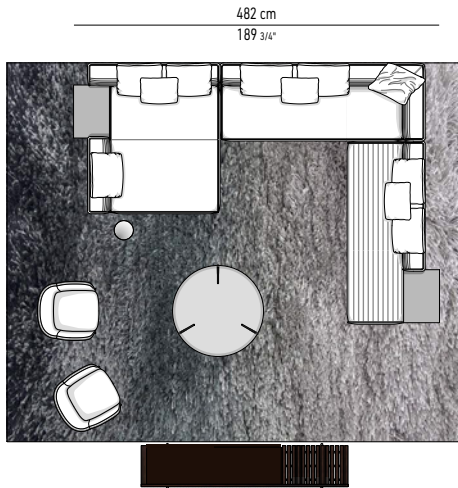

- F**
- | | |
|--|---|
| 1 SUITE Chaise-Longue Open LOW sx con CASE mod. A cm 193x197 H91 | 1 SUITE Open Chaise-Longue LOW sx mit CASE mod. A cm 193x197 H91 |
| 1 SUITE elemento terminale LOW dx cm 269x101 H91 | 1 SUITE endelement mit 1 Armlehne LOW dx cm 269x101 H91 |
| 1 SPRING elemento penisola LOW sx con CASE mod. A cm 240x121 H91 | 1 SPRING halbinselement LOW sx mit CASE mod. A cm 240x121 H91 |
| 2 Belt - poltrone cm 78x81 H71 | 2 Belt - Sessel cm 78x81 H71 |
| 1 Keel - tavolino Ø cm 120 H30 | 1 Keel - Beistelltisch Ø cm 120 H30 |
| 1 Pilotis - tavolino Ø cm 27 H45 | 1 Pilotis - Beistelltisch Ø cm 27 H45 |
| 1 Superquadra - contenitore orizzontale Living/Tv sx cm 273,5x60 H48,5 | 1 Superquadra - Living/Tv horizontales Sideboard sx cm 273,5x60 H48,5 |
| 1 Wisp Rainbow - tappeto cm 600x500 | 1 Wisp Rainbow - Teppich cm 600x500 |
| 1 SUITE Open Chaise-Longue LOW sx with CASE mod. A cm 193x197 H91 | 1 SUITE Chaise-Longue Open LOW sx avec CASE mod. A cm 193x197 H91 |
| 1 SUITE element with 1 armrest LOW dx cm 269x101 H91 | 1 SUITE élément avec 1 accoudoir LOW dx cm 269x101 H91 |
| 1 SPRING open-end element LOW sx with CASE mod. A cm 240x121 H91 | 1 SPRING élément îlot LOW sx avec CASE mod. A cm 240x121 H91 |
| 2 Belt - armchairs cm 78x81 H71 | 2 Belt - fauteuils cm 78x81 H71 |
| 1 Keel - coffee table Ø cm 120 H30 | 1 Keel - petite table Ø cm 120 H30 |
| 1 Pilotis - side table Ø cm 27 H45 | 1 Pilotis - petite table Ø cm 27 H45 |
| 1 Superquadra - Living/Tv horizontal sideboard sx cm 273,5x60 H48,5 | 1 Superquadra - bahut horizontal Living/Tv sx cm 273,5x60 H48,5 |
| 1 Wisp Rainbow - rug cm 600x500 | 1 Wisp Rainbow - tapis cm 600x500 |

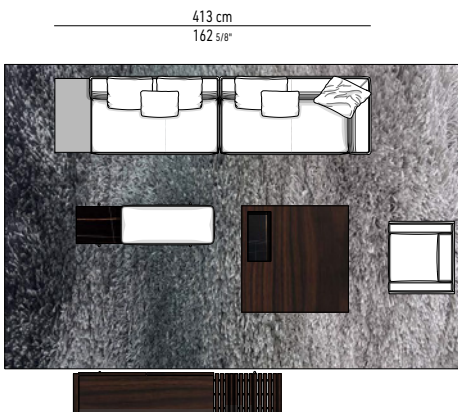

- G**
- | | |
|--|---|
| 1 SUITE elemento centrale LOW dx con CASE mod. B cm 216x101 H91 | 1 SUITE mittelelement LOW dx mit CASE mod. B cm 216x101 H91 |
| 1 SUITE elemento terminale LOW dx cm 197x101 H91 | 1 SUITE endelement mit 1 Armlehne LOW dx cm 197x101 H91 |
| 1 Brasilia - poltrona cm 95x86 H63 | 1 Brasilia - Sessel cm 95x86 H63 |
| 1 Superquadra - panca con TOP cm 182x58 H34 | 1 Superquadra - Bank mit TOP cm 182x58 H34 |
| 1 Boteco - tavolino cm 140x140 H30 | 1 Boteco - Beistelltisch cm 140x140 H30 |
| 1 Superquadra - contenitore orizzontale Living/Tv sx cm 273,5x60 H48,5 | 1 Superquadra - Living/Tv horizontales Sideboard sx cm 273,5x60 H48,5 |
| 1 Wisp Rainbow - tappeto cm 600x400 | 1 Wisp Rainbow - Teppich cm 600x400 |
| 1 SUITE central element LOW dx with CASE mod. B cm 216x101 H91 | 1 SUITE élément central LOW dx avec CASE mod. B cm 216x101 H91 |
| 1 SUITE element with 1 armrest LOW dx cm 197x101 H91 | 1 SUITE élément avec 1 accoudoir LOW dx cm 197x101 H91 |
| 1 Brasilia - armchair cm 95x86 H63 | 1 Brasilia - fauteuil cm 95x86 H63 |
| 1 Superquadra - bench with TOP cm 182x58 H34 | 1 Superquadra - banc avec TOP cm 182x58 H34 |
| 1 Boteco - coffee table cm 140x140 H30 | 1 Boteco - petite table cm 140x140 H30 |
| 1 Superquadra - Living/Tv horizontal sideboard sx cm 273,5x60 H48,5 | 1 Superquadra - bahut horizontal Living/Tv sx cm 273,5x60 H48,5 |
| 1 Wisp Rainbow - rug cm 600x400 | 1 Wisp Rainbow - tapis cm 600x400 |

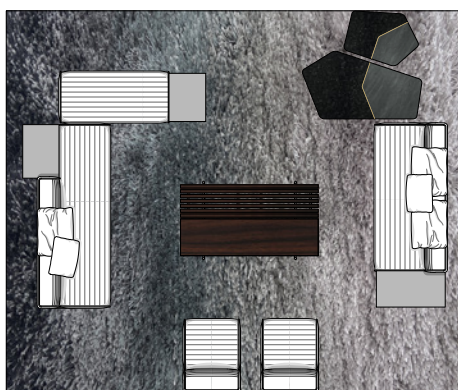

- H**
- | | |
|---|--|
| 1 SPRING SOFÀ elemento penisola LOW sx con CASE mod. A cm 240x114 H91 | 1 SPRING SOFÀ halbinselement LOW sx mit CASE mod. A cm 240x114 H91 |
| 1 SPRING UNIT panca con CASE mod.G cm 192x65 H42 | 1 SPRING UNIT Bank mit CASE mod.G cm 192x65 H42 |
| 1 SPRING SOFÀ elemento LOW sx con CASE mod. E cm 240x101 H91 | 1 SPRING SOFÀ element LOW sx mit CASE mod. E cm 240x101 H91 |
| 2 SPRING UNIT poltrone cm 72x94 H67 | 2 SPRING UNIT Sessel cm 72x94 H67 |
| 1 Superquadra - tavolino cm 180x104,5 H22 | 1 Superquadra - Beistelltisch cm 180x104,5 H22 |
| 1 Brink - tavolino cm 160x89 H30 | 1 Brink - Beistelltisch cm 160x89 H30 |
| 1 Brink - tavolino cm 95x68 H30 | 1 Brink - Beistelltisch cm 95x68 H30 |
| 1 Wisp Rainbow - tappeto cm 600x500 | 1 Wisp Rainbow - Teppich cm 600x500 |
| 1 SPRING SOFÀ open-end element LOW sx with CASE mod. A cm 240x114 H91 | 1 SPRING SOFÀ élément îlot LOW sx avec CASE mod. A cm 240x114 H91 |
| 1 SPRING UNIT bench with CASE mod.G cm 192x65 H42 | 1 SPRING UNIT banc avec CASE mod. G cm 192x65 H42 |
| 1 SPRING SOFÀ element LOW sx with CASE mod. E cm 240x101 H91 | 1 SPRING SOFÀ élément LOW sx avec CASE mod. E cm 240x101 H91 |
| 2 SPRING UNIT armchairs cm 72x94 H67 | 2 SPRING UNIT fauteuils cm 72x94 H67 |
| 1 Superquadra - coffee table cm 180x104,5 H22 | 1 Superquadra - petite table cm 180x104,5 H22 |
| 1 Brink - coffee table cm 160x89 H30 | 1 Brink - petite table cm 160x89 H30 |
| 1 Brink - coffee table cm 95x68 H30 | 1 Brink - petite table cm 95x68 H30 |
| 1 Wisp Rainbow - rug cm 600x500 | 1 Wisp Rainbow - tapis cm 600x500 |

Minotti

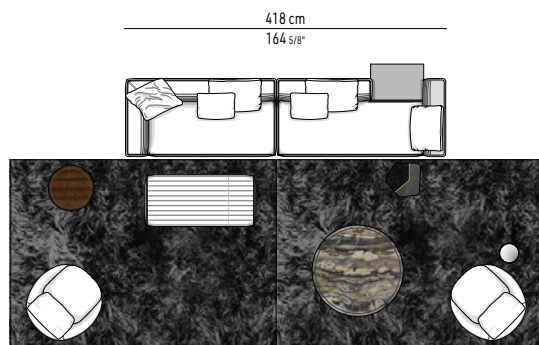

- I**
- 1 SUITE elemento terminale LOW sx cm 197x101 H91
 - 1 SUITE elemento Daybed LOW MIX dx con CASE mod. A cm 221x121 H91
 - 1 SPRING UNIT panca cm 144x65 H42
 - 2 Lido - poltrone con base cm 93X99 H85
 - 1 Keel - tavolino Ø cm 60 H45
 - 1 Keel - tavolino Ø cm 120 H30
 - 1 Brink - tavolino cm 46x44,5 H45
 - 1 Pilotis - tavolino Ø cm 27 H45
 - 2 Alps - tappeti cm 350x250
- 1** SUITE endelement mit 1 Armlehne LOW sx cm 197x101 H91
- 1** SUITE Daybed Element LOW MIX dx mit CASE mod. A cm 221x121 H91
- 1** SPRING UNIT Bank cm 144x65 H42
- 2** Lido - Sessel mit Basis cm 93X99 H85
- 1** Keel - Beistelltisch Ø cm 60 H45
- 1** Keel - Beistelltisch Ø cm 120 H30
- 1** Brink - Beistelltisch cm 46x44,5 H45
- 1** Pilotis - Beistelltisch Ø cm 27 H45
- 2** Alps - Teppiche cm 350x250
- 1** SUITE élément avec 1 accoudoir LOW sx cm 197x101 H91
- 1** SUITE élément Daybed LOW MIX dx avec CASE mod. A cm 221x121 H91
- 1** SPRING UNIT banc cm 144x65 H42
- 2** Lido - fauteuils avec piètement cm 93X99 H85
- 1** Keel - petite table Ø cm 60 H45
- 1** Keel - petite table Ø cm 120 H30
- 1** Brink - petite table cm 46x44,5 H45
- 1** Pilotis - petite table Ø cm 27 H45
- 2** Alps - tapis cm 350x250

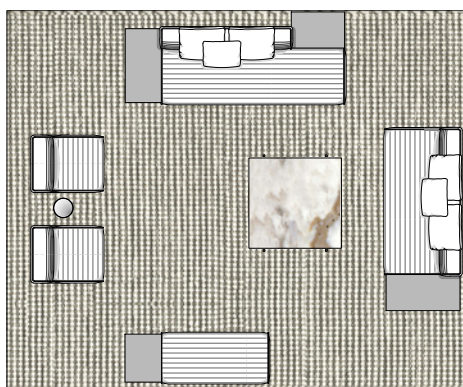

- L**
- 1 SPRING elemento penisola LOW sx con 2 CASE mod. A+B cm 288x121 H91
 - 1 SPRING elemento centrale LOW sx con CASE mod. B cm 240x101 H91
 - 1 SPRING UNIT panca con CASE mod. G cm 192x65 H42
 - 2 SPRING UNIT poltrone cm 72x94 H67
 - 1 Superquadra - tavolino cm 122x128 H22
 - 1 Pilotis - tavolino Ø cm 27 H45
 - 1 Osaka - tappeto cm 600x500
- 1** SPRING halbinselement LOW sx mit 2 CASE mod. A+B cm 288x121 H91
- 1** SPRING mittelement LOW sx mit CASE mod. B cm 240x101 H91
- 1** SPRING UNIT Bank mit CASE mod. G cm 192x65 H42
- 2** SPRING UNIT Sessel cm 72x94 H67
- 1** Superquadra - Beistelltisch cm 122x128 H22
- 1** Pilotis - Beistelltisch Ø cm 27 H45
- 1** Osaka - Teppich cm 600x500
- 1** SPRING open-end element LOW sx with 2 CASE mod. A+B cm 288x121 H91
- 1** SPRING central element LOW sx with CASE mod. B cm 240x101 H91
- 1** SPRING UNIT bench with CASE mod. G cm 192x65 H42
- 2** SPRING UNIT armchairs cm 72x94 H67
- 1** Superquadra - coffee table cm 122x128 H22
- 1** Pilotis - side table Ø cm 27 H45
- 1** Osaka - rug cm 600x500
- 1** SPRING élément îlot LOW sx avec 2 CASE mod. A+B cm 288x121 H91
- 1** SPRING élément central LOW sx avec CASE mod. B cm 240x101 H91
- 1** SPRING UNIT banc avec CASE mod. G cm 192x65 H42
- 2** SPRING UNIT fauteuils cm 72x94 H67
- 1** Superquadra - petite table cm 122x128 H22
- 1** Pilotis - petite table Ø cm 27 H45
- 1** Osaka - tapis cm 600x500

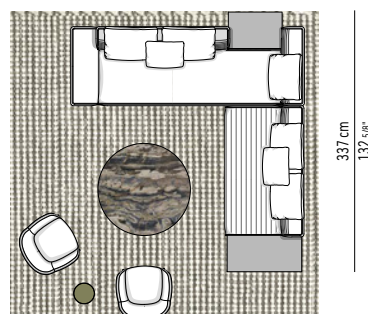

- M**
- 1 SUITE divano-Daybed HIGH SQUARE MIX dx con CASE mod. A cm 302x121 H91
 - 1 SPRING elemento centrale LOW sx con CASE mod. C cm 216x101 H91
 - 2 Belt - poltrone Lounge cm 73x72 H71
 - 1 Jigger - tavolino Ø cm 120 H30
 - 1 Pilotis - tavolino Ø cm 27 H45
 - 1 Osaka - tappeto cm 400x400
- 1** SUITE Daybed-sofa HIGH SQUARE MIX dx mit CASE mod. A cm 302x121 H91
- 1** SPRING Mittelelement LOW sx mit CASE mod. C cm 216x101 H91
- 2** Belt - Lounge Sessel cm 73x72 H71
- 1** Jigger - Beistelltisch Ø cm 120 H30
- 1** Pilotis - Beistelltisch Ø cm 27 H45
- 1** Osaka - Teppich cm 400x400
- 1** SUITE canapé-Daybed HIGH SQUARE MIX dx avec CASE mod. A cm 302x121 H91
- 1** SPRING élément central LOW sx avec CASE mod. C cm 216x101 H91
- 2** Belt - fauteuils Lounge cm 73x72 H71
- 1** Jigger - petite table Ø cm 120 H30
- 1** Pilotis - petite table Ø cm 27 H45
- 1** Osaka - tapis cm 400x400

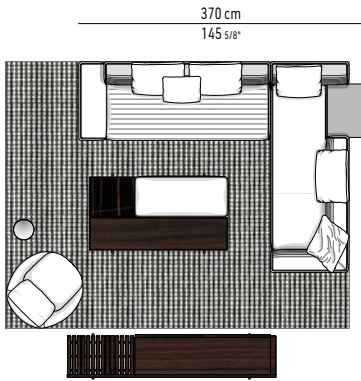

N

- | | |
|--|---|
| 1 SPRING elemento terminale HIGH SQUARE sx cm 249x101 H91 | 1 SPRING Endelement mit 1 Armlehne HIGH SQUARE sx cm 249x101 H91 |
| 1 SUITE divano-Daybed LOW MIX sx con CASE mod. A cm 274x121 H91 | 1 SUITE Daybed-Sofa LOW MIX sx mit CASE mod. A cm 274x121 H91 |
| 1 Lido - poltrona con base cm 93X99 H85 | 1 Lido - Sessel mit Basis cm 93X99 H85 |
| 1 Superquadra - panca sx con 2 TOP cm 182x102 H34 | 1 Superquadra - Bank sx mit 2 TOP cm 182x102 H34 |
| 1 Pilotis - tavolino Ø cm 27 H45 | 1 Pilotis - Beistelltisch Ø cm 27 H45 |
| 1 Superquadra - contenitore orizzontale Living/Tv sx cm 273,5x60 H48,5 | 1 Superquadra - Living/Tv horizontales Sideboard sx cm 273,5x60 H48,5 |
| 1 Osaka - tappeto cm 450x350 | 1 Osaka - Teppich cm 450x350 |
| 1 SPRING element with 1 armrest HIGH SQUARE sx cm 249x101 H91 | 1 SPRING élément avec 1 accoudoir HIGH SQUARE sx cm 249x101 H91 |
| 1 SUITE Daybed-sofa LOW MIX sx with CASE mod. A cm 274x121 H91 | 1 SUITE Canapé-Daybed LOW MIX sx avec CASE mod. A cm 274x121 H91 |
| 1 Lido - armchair with base cm 93X99 H85 | 1 Lido - fauteuil avec piètement cm 93X99 H85 |
| 1 Superquadra - banc sx with 2 TOP cm 182x102 H34 | 1 Superquadra - banc sx avec 2 TOP cm 182x102 H34 |
| 1 Pilotis - side table Ø cm 27 H45 | 1 Pilotis - petite table Ø cm 27 H45 |
| 1 Superquadra - Living/Tv horizontal sideboard sx cm 273,5x60 H48,5 | 1 Superquadra - bahut horizontal Living/Tv sx cm 273,5x60 H48,5 |
| 1 Osaka - rug cm 450x350 | 1 Osaka - tapis cm 450x350 |

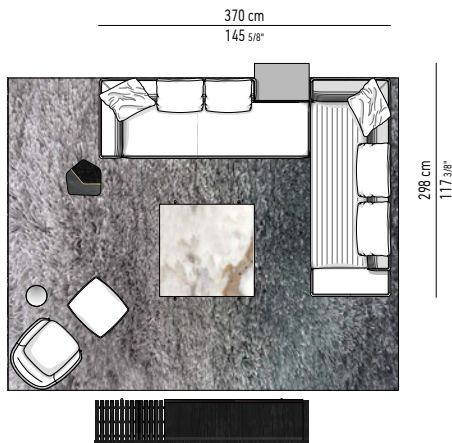

O

- | | |
|--|---|
| 1 SUITE elemento terminale penisola LOW sx con CASE mod. A cm 269x121 H91 | 1 SUITE Halbinselement mit 1 Armlehne LOW sx mit CASE mod. A cm 269x121 H91 |
| 1 SPRING divano HIGH SQUARE MIX dx cm 278x101 H91 | 1 SPRING Sofa HIGH SQUARE MIX dx cm 278x101 H91 |
| 1 Belt - bergère cm 78x84 H93 | 1 Belt - Bergère cm 78x84 H93 |
| 1 Belt - poggiatesta cm 64x58 H42 | 1 Belt - Hocker cm 64x58 H42 |
| 1 Pilotis - tavolino Ø cm 27 H45 | 1 Pilotis - Beistelltisch Ø cm 27 H45 |
| 1 Brink - tavolino cm 46x44,5 H45 | 1 Brink - Beistelltisch cm 46x44,5 H45 |
| 1 Superquadra - tavolino cm 122x128 H22 | 1 Superquadra - Beistelltisch cm 122x128 H22 |
| 1 Superquadra - contenitore orizzontale Living/Tv sx cm 273,5x60 H48,5 | 1 Superquadra - Living/Tv horizontales Sideboard sx cm 273,5x60 H48,5 |
| 1 Wisp Rainbow - tappeto cm 500x400 | 1 Wisp Rainbow - Teppich cm 500x400 |
| 1 SUITE open-end element with 1 armrest LOW sx with CASE mod. A cm 269x121 H91 | 1 SUITE élément îlot avec accoudoir LOW sx avec CASE mod. A cm 269x121 H91 |
| 1 SPRING sofa HIGH SQUARE MIX dx cm 278x101 H91 | 1 SPRING canapé HIGH SQUARE MIX dx cm 278x101 H91 |
| 1 Belt - bergère cm 78x84 H93 | 1 Belt - bergère cm 78x84 H93 |
| 1 Belt - footstool cm 64x58 H42 | 1 Belt - repose-pied cm 64x58 H42 |
| 1 Pilotis - side table Ø cm 27 H45 | 1 Pilotis - petite table Ø cm 27 H45 |
| 1 Brink - side table cm 46x44,5 H45 | 1 Brink - petite table cm 46x44,5 H45 |
| 1 Superquadra - coffee table cm 122x128 H22 | 1 Superquadra - petite table cm 122x128 H22 |
| 1 Superquadra - Living/Tv horizontal sideboard sx cm 273,5x60 H48,5 | 1 Superquadra - bahut horizontal Living/Tv sx cm 273,5x60 H48,5 |
| 1 Wisp Rainbow - rug cm 500x400 | 1 Wisp Rainbow - tapis cm 500x400 |

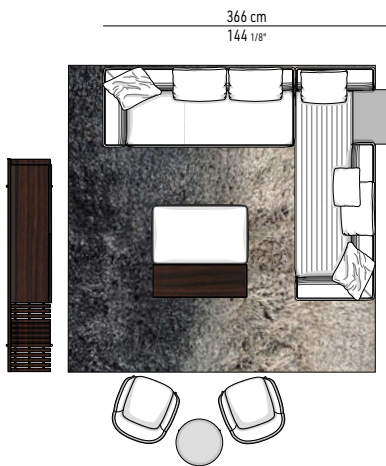

P

- | | |
|--|---|
| 1 SUITE elemento terminale LOW sx cm 245x101 H91 | 1 SUITE Endelement mit 1 Armlehne LOW sx cm 245x101 H91 |
| 1 SPRING divano-Daybed LOW sx con CASE mod. A cm 298x121 H91 | 1 SPRING Daybed-Sofa LOW sx mit CASE mod. A cm 298x121 H91 |
| 2 Belt - poltrone cm 78x81 H71 | 2 Belt - Sessel cm 78x81 H71 |
| 1 Superquadra - panca con TOP cm 126x128 H34 | 1 Superquadra - Bank mit TOP cm 126x128 H34 |
| 1 Keel - tavolino Ø cm 60 H45 | 1 Keel - Beistelltisch Ø cm 60 H45 |
| 1 Superquadra - contenitore orizzontale Living/Tv sx cm 273,5x60 H48,5 | 1 Superquadra - Living/Tv horizontales Sideboard sx cm 273,5x60 H48,5 |
| 1 Wisp Rainbow - tappeto cm 400x400 | 1 Wisp Rainbow - Teppich cm 400x400 |
| 1 SUITE element with 1 armrest LOW sx cm 245x101 H91 | 1 SUITE élément avec 1 accoudoir LOW sx cm 245x101 H91 |
| 1 SPRING Daybed-sofa LOW sx with CASE mod. A cm 298x121 H91 | 1 SPRING canapé-Daybed LOW sx avec CASE mod. A cm 298x121 H91 |
| 2 Belt - armchairs cm 78x81 H71 | 2 Belt - fauteuils cm 78x81 H71 |
| 1 Superquadra - bench with TOP cm 126x128 H34 | 1 Superquadra - banc avec TOP cm 126x128 H34 |
| 1 Keel - side table Ø cm 60 H45 | 1 Keel - petite table Ø cm 60 H45 |
| 1 Superquadra - Living/Tv horizontal sideboard sx cm 273,5x60 H48,5 | 1 Superquadra - bahut horizontal Living/Tv sx cm 273,5x60 H48,5 |
| 1 Wisp Rainbow - rug cm 400x400 | 1 Wisp Rainbow - tapis cm 400x400 |