

Levante by Pier Luigi Frighetto



IT Elegante ed eclettico, il divano modulare Levante risponde in modo brillante alle molteplici e mutevoli esigenze della zona giorno. Rompendo i classici schemi, la seduta non presenta un orientamento fisso, ma bifacciale. Lo schienale a rullo basculante, infatti, si ribalta con un semplice gesto, sia nel modulo centrale che nella chaise longue.

Un elemento angolare, uno terminale e pouf di diverse dimensioni completano l'ampia modularità, dando vita ad innumerevoli composizioni, perfette anche al centro stanza. Caratteristica comune a tutti gli imbottiti sono le forme compatte e morbide, delineate da una bordatura in Gros Grain, detta piping.

EN Elegant and eclectic, the modular Levante sofa is a brilliant solution for the multiple, shifting needs of a living area. Breaking with traditional design schemes, the seat has a double-sided orientation, not just one fixed position. In both the central and chaise longue modules, the swing-action roller backrest is moved from one side to the other with a simple gesture. The impressive range of modular options is completed with a corner element, end terminal element and different-sized poufs, allowing countless configurations, perfect even in the centre of the room. All of the upholstered seats share the common feature of compact, soft forms defined with gros grain piping along the edges.

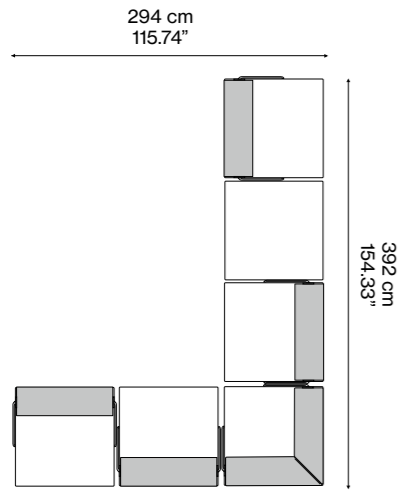

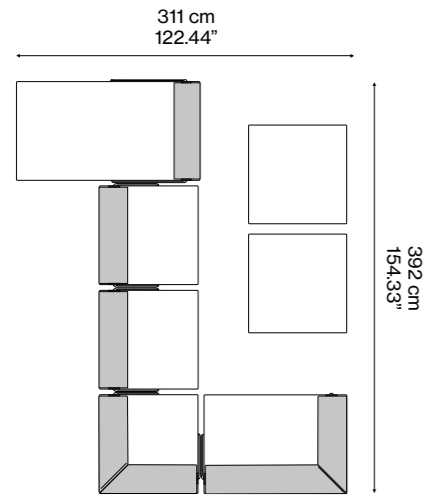

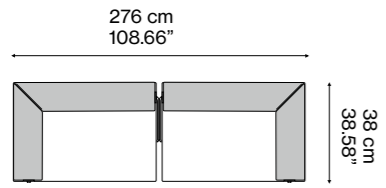





Levante by Pier Luigi Frighetto

Modulo centrale / Central module

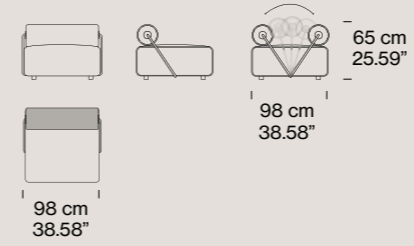

Poltrona / Armchair

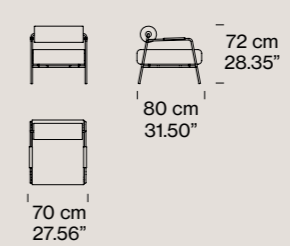

Modulo angolare (Dx/Sx) / Corner module (Rgt/Lft)

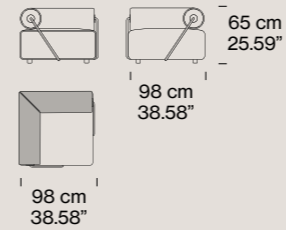

Modulo laterale (Dx/Sx) / Side module (Rgt/Lft)

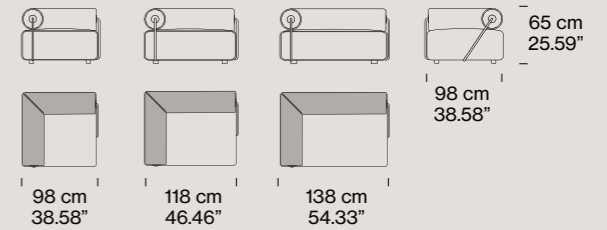

Modulo Laterale (Dx/Sx) / Side module (Rgt/Lft)

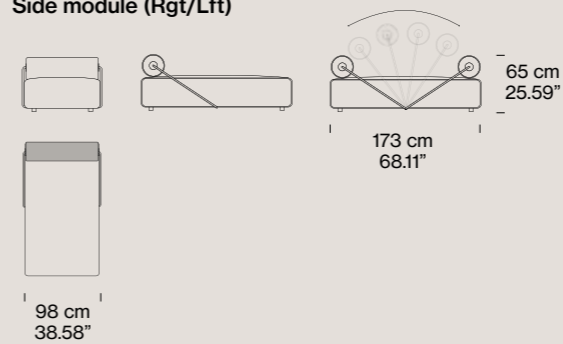

Pouf / Ottoman

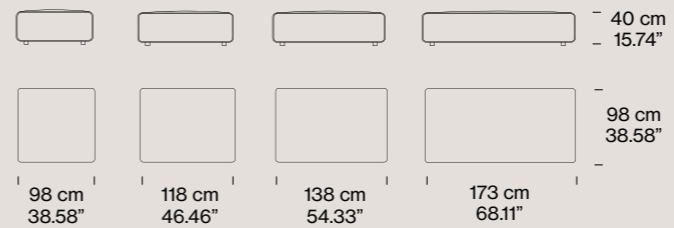

Finiture / Finishes

Rivestimento

Tessuto

Cover

Fabric

Struttura

Finiture Metallo opaco (Bronzo, Cromo, Titanio)

Structure

Matt Metal Finishes (Bronzo, Cromo, Titanio)

Pianca S.p.A
Via dei Cappellari, 20
31018 – Gaiarine, Treviso
Italy

T +39 0434 756911
F +39 0434 75330

info@pianca.com
pianca.com

p. iva IT01682580269

Vietata la riproduzione a qualsiasi scopo.
Campione promozionale gratuito non destinato alla vendita.
Escluso iva art.2 comma 3D.P.R. 633/72
Esonerato da documento di trasporto art.4 punto 6 d.p.r.627/78

Reproduction prohibited for any purpose.
Free promotional sample not for sale.
Excluding VAT Article 2 paragraph 3D.P.R. 633/72
Exempted from transport document art.4 point 6 d.p.r.627/78

© Pianca 2023

Pianca azienda
certificata FSC®



**Il marchio della
gestione forestale
responsabile**

Chiedi i prodotti
certificati FSC®