

The factory lamp s

by Ramón Esteve

Vondom's The Factory collection, designed by Ramón Esteve, is inspired by the cast-iron architecture of New York. This collection combines an industrial aesthetic with modern comfort, offering a selection of furniture that brings character and sophistication to any outdoor space.



Info

Description

Designer lamp. The deployed mesh is made from aluminum, and the inner lighting is made out of polyethylene resin manufactured by rotational molding. Suitable for an interior and an outdoor use. Available in various finishes.

Weight: 3.99 Kg

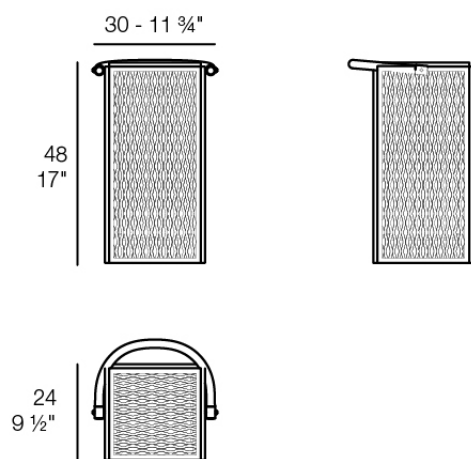

THE FACTORY Lámpara 30 x 24 x 48
THE FACTORY Puff S 11 3/4 x 9 1/2 x 19"

Finishes

lighting

RGBW LED BATTERY

Ref. 54612Y



white



smoked



ecru

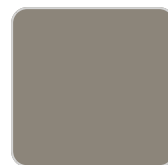

tortora



cream

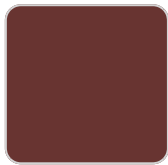

garnet

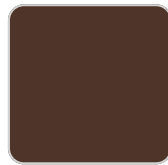

brown



green



blue



gray

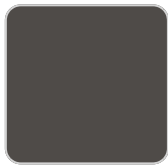

anthracite

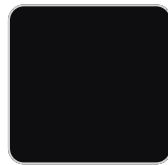

black

Unit with internal lighting with battery-powered RGBW LED technology. Includes charger and remote control for switching colors and charger. Available only in matte ice white finish.

RGBW LED DMX BATTERY

Ref. 54612DY



white



smoked



ecru



tortora

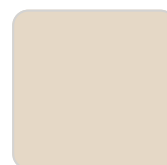

cream

VONDOM

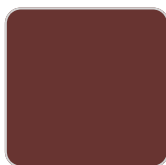

garnet



brown



green



blue



gray

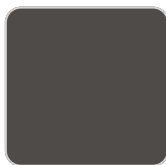

anthracite

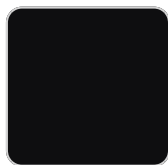

black

Unit with internal lighting with RGBW LED technology and remote control unit for switching colors. Also controlled by DMX-1024 (wireless), enabling communication between one or more products simultaneously via the DMX transmitter (not included). There are two options to choose from: Professional XLR DMX and Home WIFI DMX. (Remote control included).

Ambients

