

## Tulum dining table

by Eugeni Quitllet

Tulum, designed by Eugeni Quitllet, is a collection of designer furniture to live freely anywhere in the world.



## Info

---

### Description

Eugeni Quitllet's dining table reflects the perfect combination of technology and noble materials that characterises the collection. Its aluminium structure, with carefully welded tubes treated with epoxy paint, ensures exceptional strength and

durability. The table top is made of elegant teak wood slats from Indonesia, adding a natural and distinguished touch.

Weight: 38 Kg

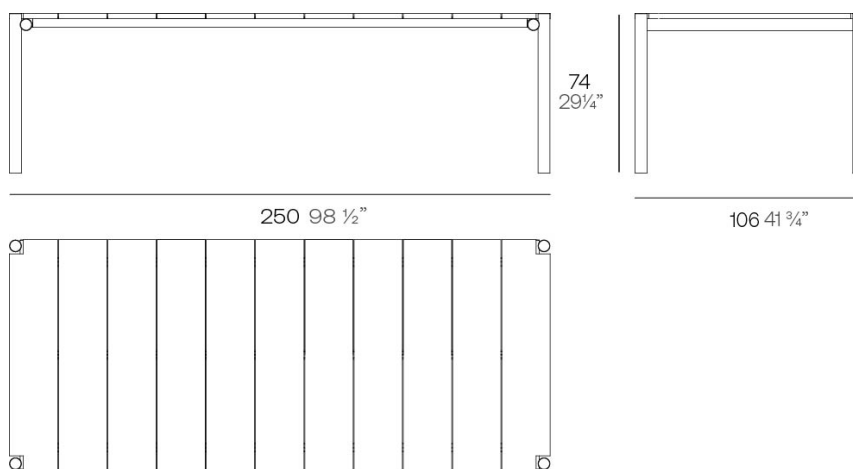

Tulum. Mesa Comedor  
Tulum. Dinnig Table  
ref. 65075

## Finishes

---

### finishes

---

#### ALUMINIUM

Ref. 65075E



white



smoked

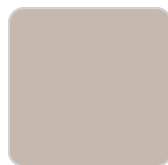

ecru

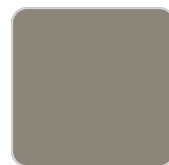

tortora



cream

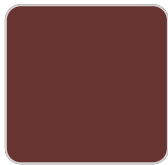

garnet

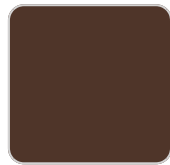

brown



green



blue



gray

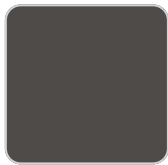

anthracite

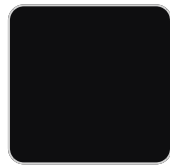

black

### tabletops

---

#### Teak

Ref. 65075TBL



natural teak



weathered teak

## Ambients

---

