

## Vases table ø60x74

by JM Ferrero

VASES Collection, is made up of flowerpots, furniture and lighting designed by the Valencian designer JM Ferrero. It's shapes were inspired by diamond cutting, producing pieces of clear-cut shapes and great style, creating a big visual impact.



## Info

---

### Description

Made of polyethylene resin by rotational moulding. 100% Recyclable. Item suitable for indoor and outdoor use. Available in different finishes.

Weight: 5.92 Kg

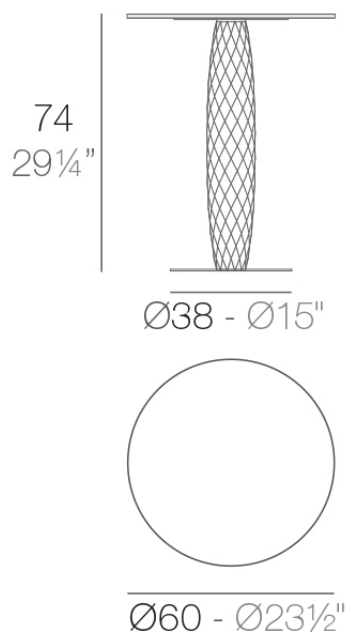

VASES Mesa Redonda Ø60  
VASES Round Dining Table Ø23 1/2"

## Finishes

---

### finishes

---

#### LACQUERED

Ref. 47073F



white 3101



ecru 3103



tortora 3104

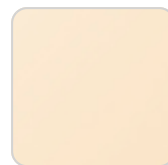

cream 3117



garnet 3113



brown 3125



green 3116



blue 3118



gray 3105



anthracite 3106



black 3102

#### Lacquered Polyethylene

### tabletops

---

#### HPL

Ref. 47073

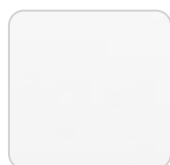

# VONDOM

orange

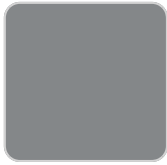

gray 2005

white 201

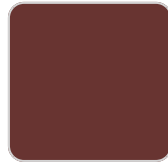

garnet 2015

ecru 2003

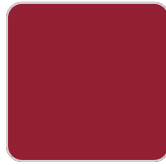

red

tortora 2004

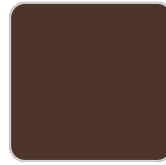

brown 2008

cream 2017

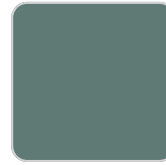

green 2016



blue 2018



anthracite 2006



black 2002

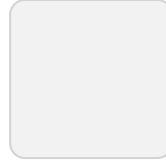

ice 2101



khaki

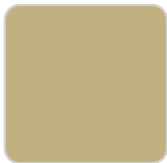

beige

HPL black edge

## tabletops

---

HPL

Ref. VVAR03006

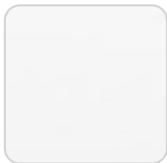

white(black edge)



ecru(black edge)

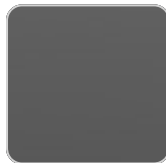

black(black edge)

HPL black edge

Solid Core

Ref. VVAR03006

# VONDOM



ecru stone



tortora stone



black stone

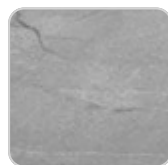

gray stone



white stone



smoked



ecru



tortora



cream

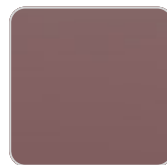

garnet



brown



green



blue



anthracite

