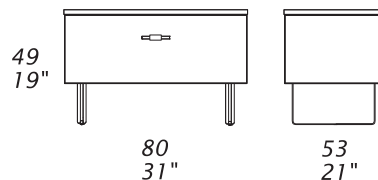
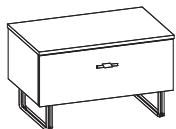
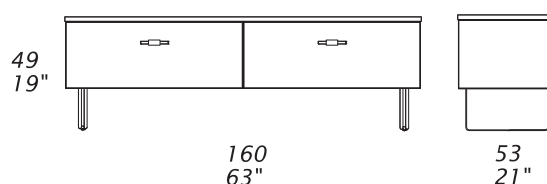
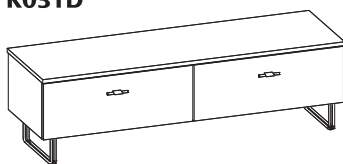
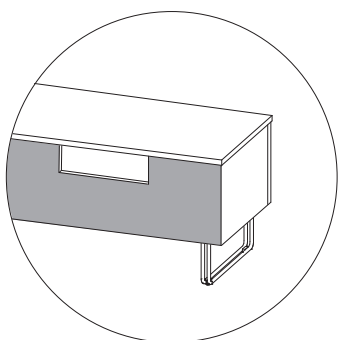
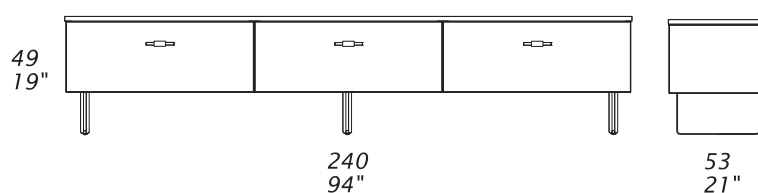
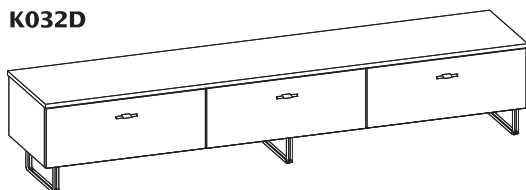

CARATTERISTICHE STANDARD

- Struttura in legno rivestita in pelle.
- Ripiano in vetro disponibile in tutte le finiture presenti in collezione.
- Ripiano in ceramica disponibile in tutte le finiture presenti in collezione.
- Ripiano in marmo disponibile in tutte le finiture presenti in collezione.
- Piedi in metallo altezza 17 cm, disponibili in tutte le finiture presenti in collezione.
- Maniglie in metallo disponibili in tutte le finiture presenti in collezione.
- Cucitura CUC 507.

STANDARD FEATURES

- Hard wood frame covered in leather.
- Glass top available in all customizing finishes.
- Ceramic top available in all customizing finishes.
- Marble top available in all customizing finishes.
- Metal legs height 17 cm - 7", available in all customizing finishes.
- Metal handles available in all customizing finishes.
- Stitching CUC 507.

**Scheda tecnica – Technical sheet****K030D****K031D****K032D**

- Il retro del mobile è rivestito in pelle, con apertura per passaggio cavi. Specificare nell'ordine se si vuole il retro chiuso rivestito in pelle.
- The back of the cabinet is covered with leather with opening for cable passage. Make sure to specify in the order if you want the back closed covered with leather.

NOTE

- Dimensioni: la prima cifra indica i centimetri, la seconda cifra indica i pollici.
- Disponibile solo con cucitura standard.



Double metal tube leg



Flat sled metal leg

NOTES

- Dimensions: the first figure shows sizes in centimeters, the second in inches.
- Available only standard stitching.